

ROBERTS

Stream 94i

DAB/FM/WiFi Smart Radio with Internet Radio, Music Player and Spotify Connect

and remote control from iPhone and Android using UNDOK



Please read this manual before use

Contents

Introduction	1-8	Manual Tuning	46
Stream 94i Smart Radio features	2	Dynamic Range Control settings	47
Before you can use this product	3	Station order setup and Prune stations	47
About this instruction manual.....	4	FM mode	48-49
Controls and connections	5-6	Manual tuning	48
Remote control battery replacement	7	Scan setting & Stereo / Mono switching	49
Navigation controls	8	Bluetooth mode	50-53
Configuration	9-20	Connecting Bluetooth devices	50
Plugging in and language selection	9	Playing audio files in Bluetooth mode.....	51
Clock and time settings	10	Connecting and reconnecting a Bluetooth device	51
Connecting to your computer network.....	11-16	Bluetooth information.....	52-53
Download the UNDOK app.....	17-19	Clock and Alarms	54-59
Network remote control options.....	20	Automatically updating the clock	54
Internet Radio mode	21-29	Setting the clock format	54
Internet Radio - the basics.....	21	Manually setting the clock & Clock style.....	55
Selecting a radio station by location and genre.....	22	Setting the alarm clock	56-57
Searching for a radio station by name.....	22	Snooze timer	58
Selecting a new or popular station	23	Disabling alarms	58
Selecting a podcast & Last listened.....	23	Sleep timer & Kitchen timer	59
Presetting stations Internet Radio, DAB and FM.....	24-25	Display and Audio	60-62
Customising your radio	26-28	Equaliser function	60
Display options Radio / Bluetooth / Music Player.....	29	Brightness control.....	61
Music Player mode	30-41	Headphone socket and Line out socket	61-62
Use with Windows, Apple Mac, Linux, USB memory	30	Auxiliary input socket	62
Accessing your audio files via UPnP using Windows 7, 8 & 10....	31-32	Inactive Standby feature.....	62
Locating and playing media files using UPnP	33-35	Information	63-70
Using USB memory devices.....	36-37	Factory reset.....	63
Playlists & Prune servers.....	38-39	Electro-magnetic compatibility advice	63
Wake On LAN.....	39	Product markings.....	63
Windows 'Play To / Cast to Device' function (UPnP renderer)	40-41	Software update & Network profiles	64
Spotify Connect	42-44	Software version display and Audio FAQ	65
Spotify Connect - the basics.....	42	Friendly name.....	65
Set up a Spotify account.....	42	Troubleshooting.....	66-67
Playing music using Spotify Connect	43	Audio codecs	68
Controlling Spotify on your radio & Friendly name	44	Cautions and Specifications	69
DAB mode	45-47	Software License Information.....	70
Selecting a DAB radio station.....	45	Guarantee.....	Back page
Finding new DAB radio stations	46		

Stream 94i Smart Radio features

The Roberts Stream 94i Smart Radio is a radio which provides the following features in an attractive compact unit:-

- Listen to local, regional, national and international broadcasts using FM, DAB and Internet radio
- Listen to over 1000 radio stations from around the country, and over 10,000 from around the world without using your PC.
- Listen to podcasts from a wide range of broadcasters.
- 120 radio station presets (40 Internet Radio, 40 DAB and 40 FM).
- Use the Music Player to play your music collection from devices on your network. Connection to Apple and Linux based computers is also possible.
- Playback of audio files from USB memory devices.
- MP3, WMA, AAC, FLAC, ALAC (Apple Lossless) and WAV formats are supported.
- The Stream 94i connects to your home computer network, either using WiFi or via a wired Ethernet connection. Dual band WiFi allows compatibility with a wide range of networks.
- WiFi Protected Setup (WPS) is supported for simpler setting up with compatible wireless routers.
- Works with Windows 'Play to' / 'Cast to Device' function (as a Digital Media Renderer).
- All radio station presets, network configuration details and user settings are retained in the event of a power failure.
- Spotify Connect allows your Spotify selections to be played through the radio, remotely controlled from your iPhone, iPad, Android device or any Desktop.
- Supports remote control and plays music from Apple iPhone, iPad and Android devices using the UNDOK app.
- Bluetooth streaming to play your music or video soundtracks from your smartphone, tablet or similar device.
- Large clock display with time and date when in Standby.
- Two alarm timers with snooze feature to wake you to either a buzzer or a radio alarm. Adjustable sleep timer, can be set to turn the radio off after a delay of between 5 and 120 minutes.
- A convenient and easy to use Kitchen Timer, that may be set in one minute increments up to a maximum of 5 hours.
- Menu display in a choice of languages - Danish, Dutch, English, Finnish, French, German, Italian, Norwegian, Polish, Portuguese, Spanish, Swedish, Turkish, Welsh.
- Power saving Inactive Standby.
- Easy-to-read colour graphic display with an adjustable display backlight.
- Auxiliary input for playing audio from MP3 players, iPods or other audio equipment.
- Line output socket for connecting the audio signal to an external amplifier or recorder. Stereo headphone socket for private listening.
- High quality three way speaker system with bass woofer.
- Mains or battery powered using supplied mains adaptor or optional rechargeable battery pack (not included).

Before you can use this product

Before you can use your radio, you must have the following:

- A broadband Internet connection (not required for DAB, FM or Music Player functions).
- A router (or equivalent wireless access point) providing a WiFi signal or Ethernet connection, connected to your broadband Internet Service Provider. The broadband modem, router and wireless access point will often be a single combined unit supplied by your Internet Service Provider or bought from a computer store.
- A Smart phone or tablet which uses either the Android operating system (version 4.0.3 or later) or Apple iOS (version 8 or later).
- If your wireless network requires a security password to allow connection, then you either need to know the WEP, WPA or WPA2 key used for encryption so that you can get the radio to communicate with the network, or your router needs to offer WiFi Protected Setup (WPS).
- If you choose to connect the radio to your network using a wired Ethernet connection, then an Ethernet cable of appropriate length will be needed. If it is intended to listen to FM radio extensively, then there may be benefit in using a shielded Ethernet cable since this may reduce possible interference to the radio.

The radio's WiFi system is compatible with 802.11b, g, n or a networks and can use 2.4 GHz or 5 GHz WiFi frequency bands.

If connecting using WiFi, the radio will typically work within a 10-20 metre radius from your wireless access point. The actual range achieved will depend upon the building type, other nearby wireless networks, and possible interference sources. DAB and FM radio functions can operate wherever the radio is able to receive a suitable broadcast signal.

IMPORTANT: Before you continue, make sure that your router (or access point) is powered up and working with your broadband Internet service (use your computer, smart-phone or tablet to verify this). To get this part of the system working you must refer to the instructions supplied with those items.

About this instruction manual

This instruction manual is split into sections for each of the operating modes of your Roberts Stream 94i internet radio. Each section is clearly identified by the shaded heading in the top right hand corner of each pair of pages.

Before using the Internet Radio and Music Player functions, you will need to connect your radio to your computer network using either the WiFi or Ethernet connection. This is covered in the section titled **Configuration**. This section also explains how to set the menu language option.

The **Internet Radio** section describes how to find radio stations to listen to. These can be radio stations that you already know and listen to conventionally, or new stations you may search for. You may set up stations that you like as Favourites so that they are more readily accessible.

The section for the **Music Player** describes how you may play music files that you may have stored on a computer connected to your network. The use of Shared Media (using UPnP) and USB playback is explained.

The **Spotify Connect** section explains the use of the radio in conjunction with the Spotify internet based music streaming service.

The two sections for **DAB** and **FM Radio** describe how to use the radio to listen to conventional radio broadcasts.

The **Bluetooth** section describes how to use your Stream 94i to play audio files or video soundtracks directly from your smartphone, tablet or similar devices.

The section titled **Clock** and **Alarms** describes the different ways by which the clock in the radio may be set, as well as explaining the use of the alarms, snooze and sleep timer features.

The **Display** and **Audio** section shows how to adjust the display, use the equaliser and connect your radio to other audio equipment.

The **Information** section includes troubleshooting, specifications and warranty information.

Introduction

Configuration (page 9)

Internet Radio (page 21)

Music Player (page 30)

Spotify Connect (page 42)

DAB & FM Radio (page 45)

Bluetooth (page 50)

Clock and Alarms (page 54)

Display & Audio (page 60)

Information (page 63)

Controls and connections

Front view

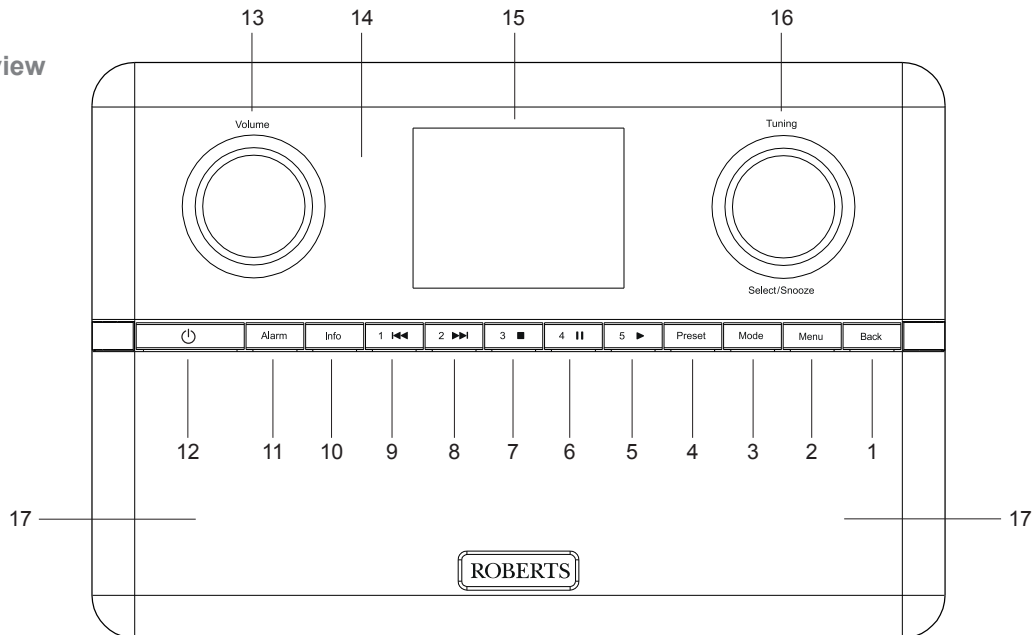

- | | | |
|-------------------------------------|-----------------------------------|--------------------------------------|
| 1. Back button | 7. Preset 3 / Stop button | 13. Volume control |
| 2. Menu button | 8. Preset 2 / Fast-forward button | 14. Remote control sensor |
| 3. Mode button | 9. Preset 1 / Rewind button | 15. Display panel |
| 4. Preset / Repeat / Shuffle button | 10. Info / Brightness button | 16. Tuning / Select / Snooze control |
| 5. Preset 5 / Play button | 11. Alarm button | 17. Loudspeaker x 2 |
| 6. Preset 4 / Pause button | | |

Rear view

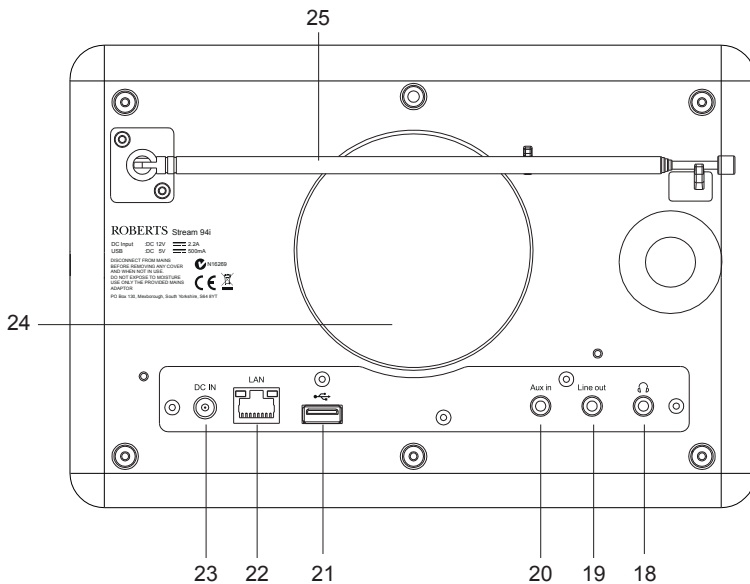

- 18. Headphone socket
- 19. Line output socket
- 20. Auxiliary input socket
- 21. USB playback socket
- 22. Ethernet socket (RJ-45)
- 23. DC input socket
- 24. Subwoofer
- 25. Telescopic aerial (antenna cable socket behind)

Remote control handset

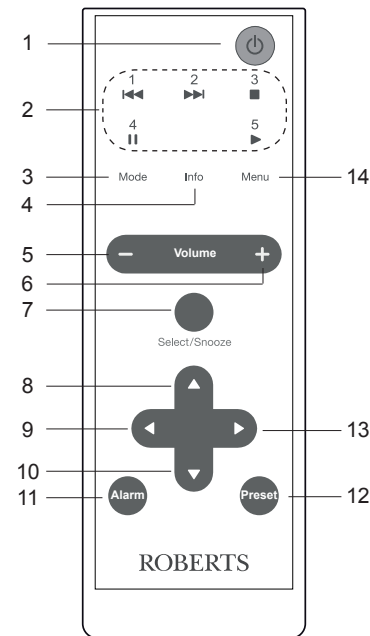

- 1. On / Standby / Sleep button
- 2. Preset buttons 1-5 / Playback control buttons
- 3. Mode button
- 4. Info / Brightness button
- 5. Volume Down button
- 6. Volume Up button
- 7. Select / Snooze button
- 8. Tuning / Menu Up button
- 9. Menu Back button
- 10. Tuning / Menu Down button
- 11. Alarm button
- 12. Preset / Repeat / Shuffle button
- 13. Menu Forward button
- 14. Menu button

Remote control battery replacement

1. Use a tool such as a coin to remove the battery cover on the rear of your remote control. Rotate the cover approximately 45 degrees in an anti-clockwise direction to align the dot on the cover with the 'OPEN' marking on the remote control. Gently tap the control to release the cover.
2. Insert 1 x CR2025 size battery into the compartment with the positive side (marked +) facing towards the battery cover, as shown on the reverse side of the battery cover.
3. Close the battery cover by re-applying the cover to the control in the position marked "Open" and then use a tool such as a coin to rotate the cover clockwise so that there is a slight click and the dot on the cover is aligned with the "Lock" marking on the remote control.
4. If the remote is not to be used for an extended period of time it is recommended that the battery is removed.

IMPORTANT: The battery should not be exposed to excessive heat such as from direct sunshine, fire or the like. After use, disposable batteries should if possible be taken to a suitable recycling centre. On no account should batteries be disposed of by incineration.

Do not leave batteries within reach of young children. They can be a choking hazard.



WARNING:

- Do not ingest the battery. Chemical Burn hazard.
- The remote control supplied with this product contains a coin/button cell battery. If the coin/button cell battery is swallowed it can cause severe internal burns in just 2 hours and can be fatal.
- Keep new and used batteries away from children.
- If the battery compartment does not close securely, stop using the product and keep it away from children.
- If you think batteries might have been swallowed or placed inside any part of the body, seek immediate medical attention.

CAUTION

Replace battery only with the same or equivalent type. Danger of explosion if the battery is incorrectly replaced.

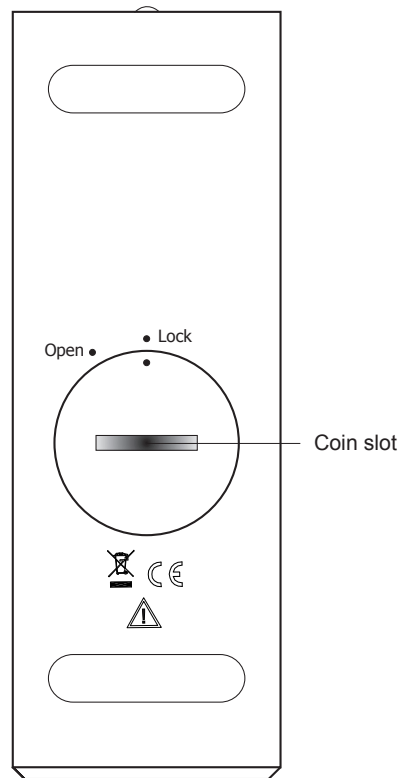

Navigation controls

This page describes the basic means of controlling your Stream 94i radio. Instructions for each operating mode are given in the later sections of this book.

1. Pressing the **On/Standby** button brings your radio out of Standby mode. Pressing **On/Standby** while the radio is in use will cause it to return to the Standby mode with the clock display.
2. Pressing the **Mode** button gives you access to each of the operating modes in turn: Internet Radio, Spotify, Music Player, DAB Radio, FM Radio, Bluetooth and Auxiliary Input. Alternatively press the **Mode** button and then turn the **Tuning/Select** control clockwise or anti-clockwise to highlight the desired menu item then press the control to select that item.
3. Pressing the **Menu** button will access the menu system.
4. Many operations require the user to make a selection from the menu. This is done using the **Tuning/Select** control. Turn the control clockwise or anti-clockwise to highlight the desired menu item then press the control to select that item.
 If there are more than six items in a menu, then the display will automatically scroll up or down so that the additional items become visible. A sliding bar on the right will give an indication showing the current portion of the menu that is displayed. If there are many items in a menu, then the radio allows the menu to 'wrap around' in either direction. This can make it easier to reach items at the end of a long menu, such as a list of countries or Internet radio stations.
5. If an error is made when navigating the menus, it is generally possible to go back to a higher level menu by pressing the **Back** button.
6. The **Info** button allows the display of information relating to the radio station or music file being played.

Note: In this booklet, press always means **press and release**. If it is required to give a long press on a button this will be described as **apply a long press** and the button should be held down for 2 to 3 seconds until the radio has responded. Although controls on the radio are shown, all functions are also available using the remote control.

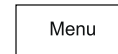
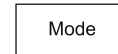
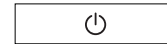

Tuning

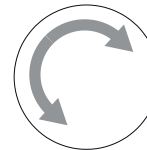

Select/Snooze

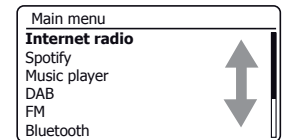
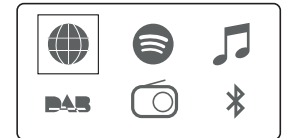
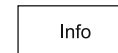
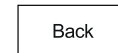

Configuration

Plugging in and language selection

Your radio may be configured using either the display and buttons on the radio, or by using the UNDOK app.

1. Place your radio on a flat surface and plug the cable from the mains adaptor into the **DC input socket** located at the rear of your radio (marked 'DC in') ensuring that the plug is pushed fully into the socket.
2. If you wish to use a wired network connection, plug the Ethernet cable into the RJ-45 socket at the back of the radio.
3. Plug the mains adaptor into a wall socket and switch on the socket.

IMPORTANT: The mains adaptor is used as the means of connecting the radio to the mains supply. The mains socket and any multi-way mains block used for the radio must remain accessible during normal use. In order to disconnect the radio from the mains, the mains adaptor should be removed from the mains socket outlet completely.

4. When you apply power, the display on the radio will light up and show a start up screen for a few seconds.

If this is the first time that you use your radio (or after a Factory Reset) the display will show 'Setup wizard' and 'YES' will be highlighted on the screen.

Note: If you wish to use UNDOK to setup your radio, please see page 17.

5. If you would like to setup your radio using the radio's controls instead of the UNDOK app then press **Tuning** to select 'YES' and to begin setting up your radio.
6. By default your radio will display all menus and messages in English. Rotate **Tuning** to highlight the desired language. Press **Tuning** to enter the selection.
Continue on the next page.

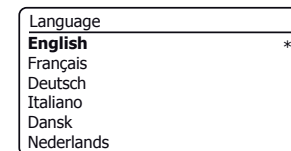
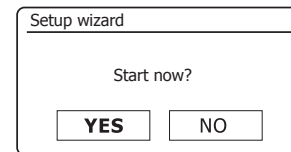
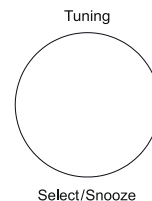
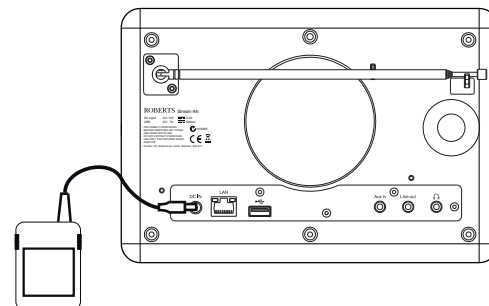

Clock and time settings

The following instructions assume that you have just plugged in your radio and you have just specified the language option for the menus (see page 9).

1. Rotate **Tuning** to highlight the desired clock format (either 12 or 24 hour) then press the control to enter your selection.
2. Next, the way in which the radio updates its clock is set. A menu allowing you to specify the auto-update option for the clock will be shown. The 'Update from Network' option will be best for most users.
3. Rotate **Tuning** to choose an auto-update option for the clock. This can be updated from the Radio, from the Network, or not updated automatically. The default is to auto-update from the network. If you choose another option go to 'Connecting to your computer network' on page 11. Otherwise you will first need to select the correct time zone and daylight savings setting, see the next steps. If you choose 'No update' you will need to set the clock manually later, see page 55. Press the control to confirm your choice.
4. Rotate **Tuning** to highlight the time zone for your current location. Press **Tuning** to enter the setting.
5. You will then need to set the Daylight Savings option according to your location (Daylight Savings is also known as Summer/Winter time or BST/GMT adjustment).
Rotate **Tuning** to highlight 'ON' or 'OFF' as required. The asterisk shows the current setting.
In the UK, 'ON' is equivalent to British Summer Time and 'OFF' is equivalent to Greenwich Mean Time.
6. Continue setting up your radio on the next page.

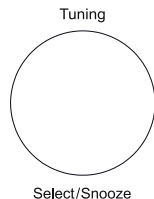

Configuration

Date/Time

12/24 hour format

Auto update

Update from Radio
Update from Network *
No update

Set timezone

UTC + 00:00: Dublin, Lond *
UTC + 00:30:
UTC + 01:00: Madrid, Am
UTC + 01:30:
UTC + 02:00: Athens, Cair
UTC + 02:30:

Daylight savings

Daylight savings

Connecting to your computer network

Before you can use your Stream 94i radio to listen to Internet radio or to music streamed from your computer, it must first be connected to your computer network.

This section of this book describes how to connect the radio to your network using either the wireless (WiFi) connection or the wired (Ethernet) connection.

The following instructions assume that you have just set up the clock and time options using the Setup Wizard as described on the preceding page.

These instructions also apply to the Network Wizard in the Network Settings menu (from step 2 onwards).

1. After setting the Daylight Savings options (see page 10), the display will show the 'Keep network connected?' option. You should choose 'Yes' if you wish to keep the radio connected to the network when it is in Standby mode. This will allow remote control software to switch on your radio when needed.

If you choose 'No' then your radio will shut down its WiFi connection when it is in Standby, DAB, FM, Bluetooth or Aux-in modes. This minimises power consumption but it does mean that you will need to switch the radio on manually in order to use either Spotify Connect, the 'Play to / Cast to Device' function or any remote control software such as the UNDOK app.

Rotate **Tuning** to highlight the required option and then press the control to make the selection.

After setting the Keep Connected option, the display will show a list of supported WiFi regional options.

Rotate **Tuning** to highlight the required region (for the UK choose 'Europe'), and then press the control to make the selection. Do this even if you are planning to use the wired Ethernet connection. Your radio will then scan for available WiFi networks.

2. The radio will enter the Network Settings Wizard and will display 'Scanning...'. The radio will automatically scan both 2.4GHz and 5GHz WiFi bands. After a short while the display will show a list of the available WiFi networks. If you are intending to use the WiFi connection, go to step 3 on the next page.

To use the Ethernet connection to your router (with automatic configuration), rotate **Tuning** to point to the '[Wired]' menu item. Press the control and the radio will attempt to connect.

If your network allows automatic configuration (which is normal) the radio will acquire a network address. The screen should say 'Connecting...', and then 'Setup wizard completed'. Press **Tuning** to exit the setup wizard and show the Main mode menu. You can then skip to paragraph 10 on page 14.

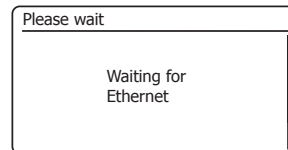
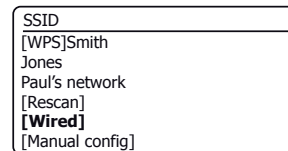
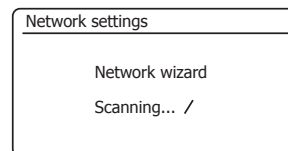
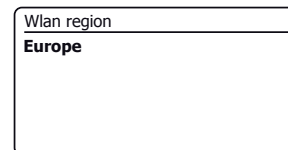
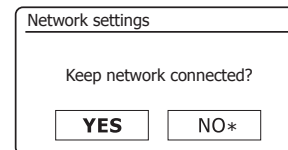

Connecting to your computer network - cont.

There are two indicator lights incorporated into the RJ-45 connector. If you have problems with your wired connection, they may help you to identify the possible cause of the problem.

Green ON = Link established; OFF = no connection

Yellow Flashing = Data transfer

If your network does not support automatic configuration or if you wish to set it up manually then you should select '*Manual config*' instead of selecting '*Wired*' in the Network Wizard, then go to page 16.

3. If you plan to use a WiFi connection, you will first need to identify your network in the list of network names presented by the Network Wizard. If no networks are found then you may have to get your wireless router working (please see the instructions supplied with it) or you may be too far from the router.

When the radio finds your wireless network, it displays the Network Name (SSID) for the wireless access point on the screen. This is a name that is allocated to the access point in your router by the person who set up the network - for example: '*Jones family*' or '*Paul's network*'. Routers supplied by Internet Service Providers often have the default name of the WiFi network provided on a label or card for easy reference (e.g. BTHub - 1234, virginmedia 1234567). If the router supports WiFi Protected Setup, then '*WPS*' will be shown in front of the SSID.

It is possible, and in some locations highly likely, that your radio will find more than one wireless network, in which case you should choose which one you need to connect to.

4. Rotate **Tuning** to see the SSID for each wireless network that has been found. If your network is shown proceed to step 6 on the next page. If it is *not* shown then proceed to step 5, also on the next page.

If you make a mistake at any point, use the **Back** button to go back to the previous screen.

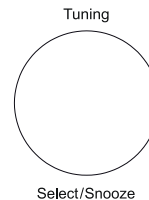

Configuration

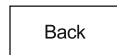
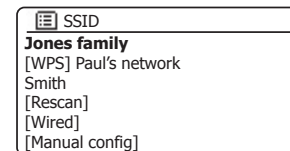
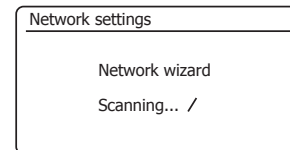
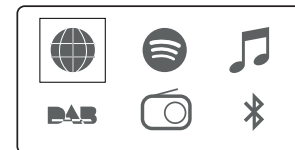
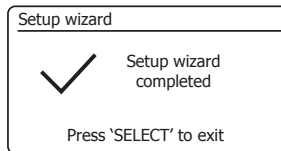

Connecting to your computer network - cont.

- If your network is not found, it may be because the router is configured not to broadcast the SSID. You should then use the **Tuning** control to highlight and select the *'Manual config'* option in order to enter the network details manually. This is described in 'Manual Network Configuration', see page 16.

If your network name is being broadcast, and it was not found, then try re-scanning (press the **Back** button), and if necessary try moving your radio to a location closer to your access point / router.

- When the SSID for the wireless network you wish to connect to is highlighted on the screen, press the **Tuning/Select** control. If WiFi Protected Setup (WPS) was indicated, you will see an additional menu at this point, otherwise proceed to step 7.

Choose one of the WPS menu options as required for your router (WPS may be via push button, or using an identification number).

'Push Button' - the display prompts you to press the WPS button on your router and then the **Tuning/Select** control on the radio. The two devices should then connect with the encryption key sent automatically to the radio.

'PIN' - the display shows an identification number which you must enter into your router using a web browser (refer to your router's user documentation). You should then press the **Tuning/Select** control on the radio. The two devices should then connect with the encryption key sent automatically to the radio.

'Skip WPS' - if you wish to enter the encryption key yourself (or if it was previously entered).

If you chose Push Button or PIN the screen will then show *'Connecting...'* and then *'Setup wizard completed'*. Press the **Tuning** control to exit the setup wizard and then go to paragraph 10 on the next page.

- If your network is configured without an encryption key, the screen should say *'Connecting...'*; and then *'Setup wizard completed'*. Press **Tuning** to exit the setup wizard and show the Main mode menu. If this is the case then you have successfully connected your radio to your network, so please go to paragraph 10 on the next page.

- If the screen displays *'Key:'*, it is because the network is using one of the encryption systems: Wired Equivalent Privacy (WEP) or WiFi Protected Access (WPA). You will need to enter the correct WEP or WPA key into the radio to allow it to communicate with your wireless network. If you do not have the WEP or WPA key, then you should obtain it from the person who set up your network. Some wireless routers may come with an encryption key already set up by the supplier, in which case you should refer to the documentation provided with it. WPA is used here to also include WPA2.

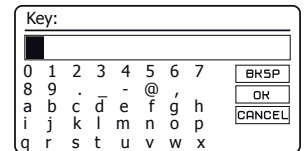
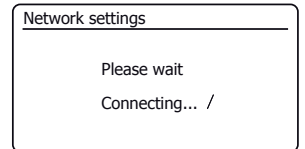
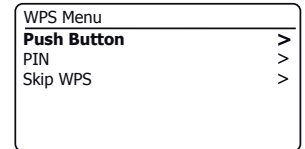
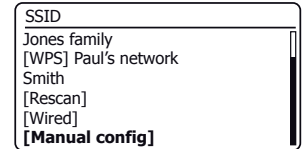
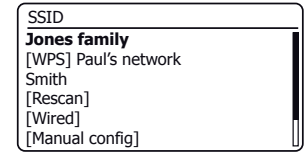

Connecting to your computer network - cont.

WEP keys are 10 or 26 characters long (using 0 - 9, and A - F). Some wireless routers can also use pass-phrases for WEP but these are not supported by the radio. WPA keys are usually set up using a pass-phrase of between 8 and 63 characters. Your radio accepts pass-phrases for WPA keys.

- To enter the WEP or WPA key, characters are selected and entered using the **Tuning** control. As you rotate the control, the highlight scrolls through the available characters as well as the three controls on the right. The character currently highlighted will be entered when you press the **Tuning** control.

Do this as needed until the complete key has been entered. *Remember, WEP keys only use the numbers 0-9 and letters A-F. WPA keys are sensitive to upper and lower case characters. You must enter the key **exactly** or the radio will not connect to the network.*

The three controls on the right-hand side of the screen have special functions. You can quickly access these by pressing the **Info** button and then using the **Tuning** control as needed:

- select '**BACKSP**' to erase a character just entered (long press to clear); **Info** again to continue
- select '**OK**' when the complete key has been entered
- select '**CANCEL**' to cancel and re-run the Network Wizard

If a WEP or WPA key has previously been entered for the selected SSID then the display will show 'Key: [Set]'. If you have previously entered a different key, you must clear this by selecting the '**BACKSP**' symbol. This will remove the '[Set]' indication.

After the final character of the WEP or WPA key has been entered, highlight the '**OK**' symbol and press the **Tuning** control. The screen will show 'Connecting...' and then 'Setup wizard completed'. Press the **Tuning** control to the exit setup wizard. The radio should now be able to connect to the network.

- Once you have connected your radio to the network (and therefore also to the Internet) it will display the Main mode menu. Press the **On/Standby** button to put the radio into Standby mode. It should then display the time as obtained from the Internet. If the time display is not correct for any reason, it can easily be adjusted later, see page 55, 'Manually setting the clock'.

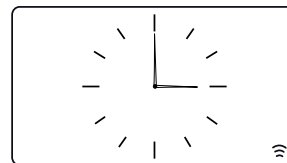
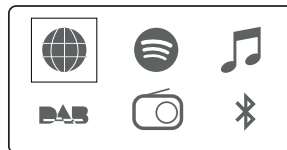
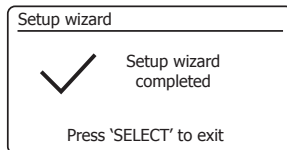
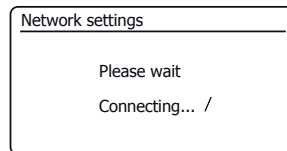
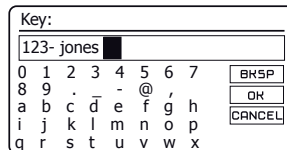
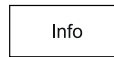
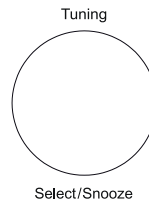

Connecting to your computer network - cont.

If you have followed the steps on the preceding pages successfully, your radio will have connected to your router, and then made a connection to the Internet and set its clock. You can then listen to radio stations via the internet and use the other features of your radio (see page 21 onwards).

Changing the network connection

In the sections above, you chose how your radio would be connected to your network, either using a WiFi connection or using a wired Ethernet cable. From time to time, you may find that you need to connect to different computer networks. The Network Settings menu allows you to change your radio's network settings, scan for an alternative wireless network, or to manually configure the network parameters.

The steps outlined below describe how you can do this - see also the section 'Network profiles' on page 64. If you have no need to do this, however, please skip to page 21.

Configuring the radio to use an alternative WiFi connection

1. From the Network Settings menu select '*Network wizard*'. This will present you with details of any WiFi networks that are found. Scroll down the list using the **Tuning/Select** control to the desired network name. Press the control to select this network.

The radio will then use its WiFi system to communicate with the network. Depending on the settings for the new network you may need to enter an encryption key (see pages 13-14). By default the radio will then acquire an IP address and other network settings from the network's router using DHCP (Dynamic Host Configuration Protocol).

Configuring the radio to use the wired Ethernet connection

2. Connect your radio to your router using an Ethernet cable plugged into the RJ-45 socket at the back of the unit. From the Network Settings menu select '*Network wizard*'. This will display a list of any WiFi networks that are found. Scroll down the list and select the '*Wired*' option.

The radio will then use its Ethernet connection to communicate with the network. By default the unit will then acquire an IP address and other network settings from the network's router using DHCP (Dynamic Host Configuration Protocol).

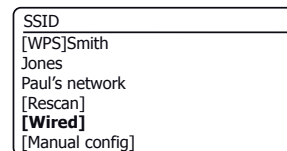
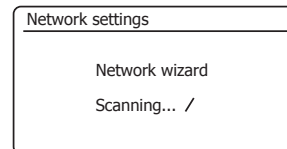
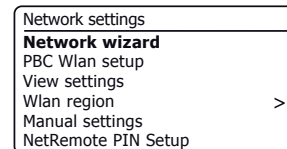
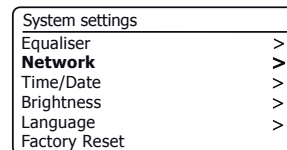
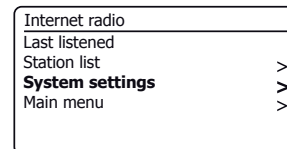

If you do not wish to use DHCP for automatic network configuration, or if your network is configured with a hidden SSID, then you will need to enter some network settings manually. The typical user will not need to use manual network configuration. The facility is provided to allow the product to be used with networks where the configuration of devices is not managed by the router, or where customised settings may be required. In such cases it is assumed that the user already has sufficient knowledge to understand the terms and settings used for this purpose. IPv4 address schemes are used.

- From the radio's Network Settings menu, select '*Manual settings*'. You must then choose whether to connect using '*Wired*' or '*Wireless*' connections. If you choose '*Wireless*' there are as many as nine settings screens, shown by the '*1 of 9*' progress marker in the top right corner of the display. If you choose '*Wired*' there are five screens and the progress marker will reflect this, although the steps to set up the network parameters are basically the same.
- The subsequent menus allow configuration of the following parameters:
 - DHCP - On or Off
 - IP address - e.g. 192.168.1.25
 - Subnet mask - e.g. 255.255.255.0
 - Gateway address - e.g. 192.168.1.1
 - DNS address (primary and secondary addresses)
 - SSID - needed for WiFi connections if the SSID is not broadcast
 - WEP / WPA / WPA2 key and settings

When entering numbers, the SSID or the WiFi pass key, the three controls on the right-hand side of the screen have special functions. You can quickly access these by pressing the **Info** button and then use the **Tuning** control as needed:

- select '**BR5P**' to erase a character just entered (long press to clear); **Info** again to continue
- select '**OR**' when the complete encryption key has been entered
- select '**CANCEL**' to cancel and go back to the TKIP / AES options screen

- Upon completion of the settings the radio should connect to the network. If the connection is made successfully, the radio will return to the Network Settings menu. If the unit cannot connect, then it will display a '*Failed to connect*' message. You will then need to identify which setting may need to be changed, or whether some other network issue is responsible. Once connected, the network settings are saved. They are retained in memory while the radio is disconnected from the mains.

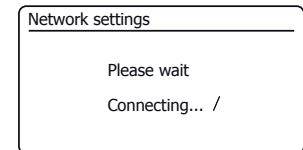
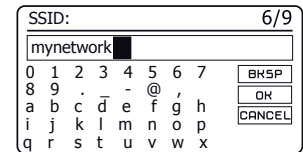
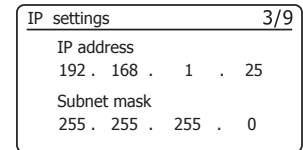
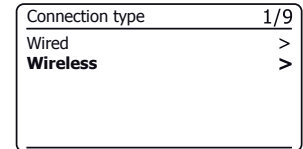
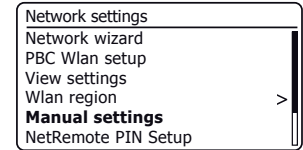

Configuration - Using the UNDOK app

Download the UNDOK app

Download and install the UNDOK app on to your Android or iOS device.



- iOS - Download from Apple App Store
- Android™ - Download from Google Play



- If you already have the UNDOK app installed on your device ensure that you have the latest version.
- It is possible that this app may have been changed slightly since these instructions were written.
- Please refer to the Roberts Radio website for guidance on how to use the latest version.

Note: At the time of writing Android version 4.0.3 and later or iOS version 8 or later are required to use UNDOK.

Setup new audio system - Apple iOS device

If your device uses Android, please see page 19.

The **UNDOK app** has a setup wizard to help configure suitable audio devices to connect to your home WiFi network.

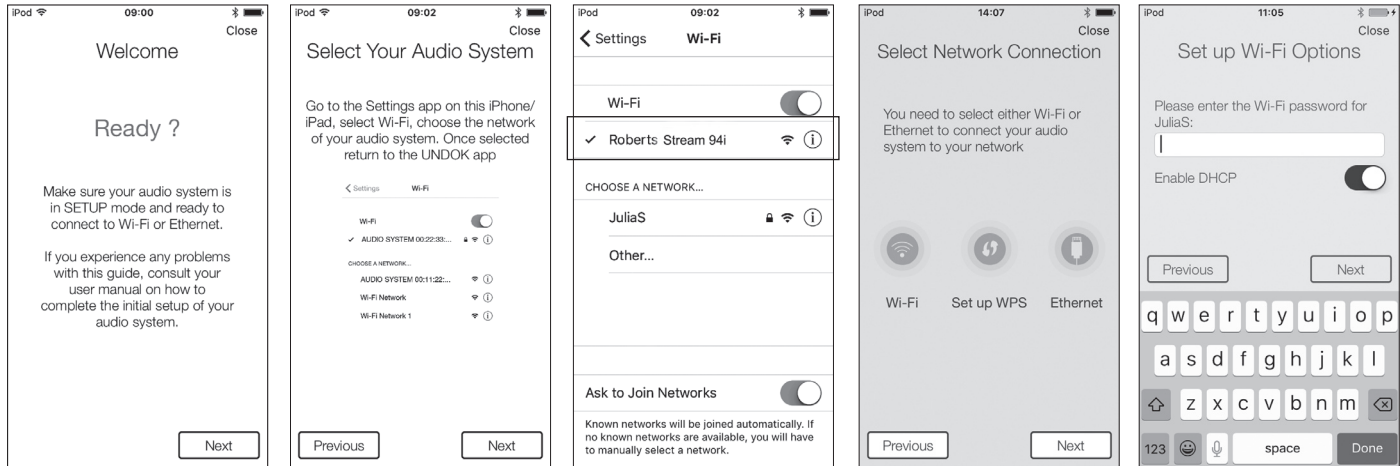

1. Open the **UNDOK app**.
2. Setup a **New Audio system**.
3. The app will prompt you to use your **device's WiFi** settings to connect to your radio.
4. Select your **Stream 94i** radio. Once your device has connected to the radio, **return** to the UNDOK app.
5. Use the app to complete the setup, including giving the radio a name, whether it is connected via Wi-Fi or Ethernet. If you wish to connect using an Ethernet cable please (see page 9).
6. For a Wi-Fi connection the app will ask you to choose a Wi-Fi network and enter the appropriate password.
7. Your radio will connect to your network.

Setup new audio system - Android device

If your device is an iPhone or iPad (i.e. uses iOS) please see page 18.

The **UNDOK app** has a setup wizard to help configure suitable audio devices to connect to your home WiFi network.

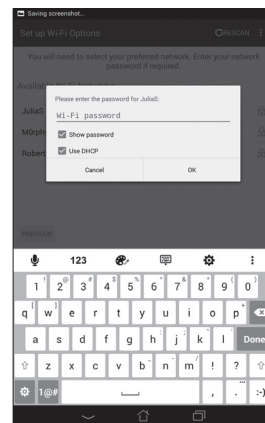
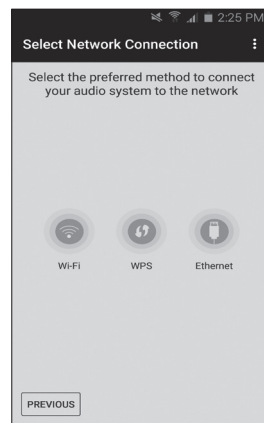
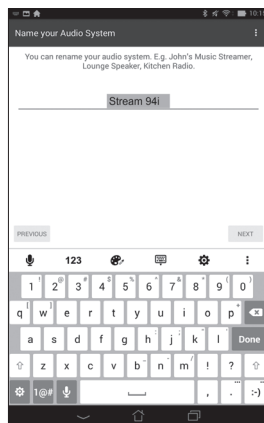
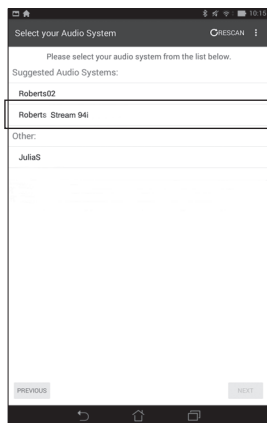
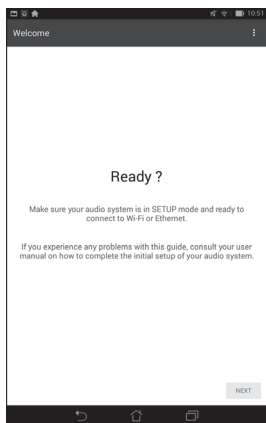

1. Open the **UNDOK app**.
2. Setup a **New Audio system**.
3. The app will show a list of suggested audio systems to setup.
4. Your radio will normally appear in this list as **Stream 94i**. It may appear in the list below called **Other**. Select the radio to be setup.
5. Use the app to complete the radio setup, including giving the radio a name.
6. Choose whether it is connected via WiFi or Ethernet. If you wish to connect using an Ethernet cable please (see page 9).
7. For a WiFi connection the app will ask you to choose a WiFi network and enter the appropriate password.
8. Your radio will connect to your network.

Note: If when setting up your radio your Android device complains that it cannot connect to the internet this is because it is temporarily connected directly to your radio. You should ignore this warning message.

Network remote control options

Network PIN setup (PIN number)

Your radio has the option of being controlled by an application installed on an Apple iPhone, iPod touch, iPad or equivalent Android device. The PIN number facility allows you to ensure that your radio can only be controlled by your own device rather than someone else's.

The remote control application is called UNDOK, by Frontier Silicon Limited, and is available from the Apple App Store and Google Play for your device.

UNDOK will try to use the default PIN of '1234' to control your radio.

You may change the PIN if desired using the 'NetRemote PIN Setup' option in the Network settings menu. The updated PIN should then be used in the UNDOK app to allow the app to reconnect to the radio. The app will prompt you for the PIN as needed.



Control via the UNDOK app

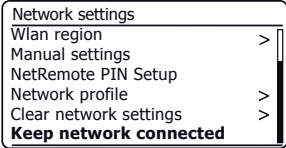
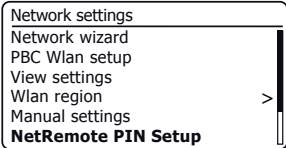

Keep network connected

Your radio has the option to shut down its WiFi or Ethernet connection when it is in Standby. This minimises power consumption but it does mean that you will need to switch the radio on manually in order to use either Spotify Connect, the 'Play to / Cast to Device' function or any remote control software such as the UNDOK app.

If you need to be able to remotely control the radio even when it has been put into Standby, then you can choose to keep the network connected by using the 'Keep network connected' option in the network settings menu. In the Standby mode display the WiFi signal indicator is shown with or without a cross through it, or the Ethernet connection indicator is shown unplugged or plugged in, according to the state of the connection.

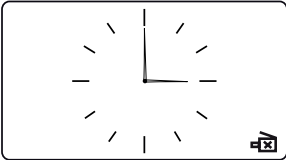
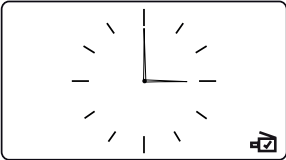
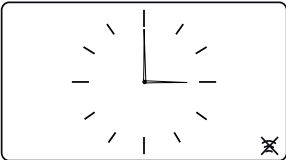
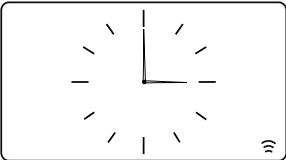

Internet Radio

Internet Radio - the basics

Before you can use your radio to listen to broadcasts via the Internet, it is necessary to have connected it to your computer network using either the wireless (WiFi) connection or the wired Ethernet connection (RJ-45 socket) located on the back of the unit. Please see page 9 for details.

There are literally many thousands of radio broadcasts available via the Internet as well as 'Podcasts'. Your radio provides several ways of searching for broadcasts in order to make finding and choosing them easier. Once you have found the radio stations that you like, you may either store them as presets within the radio, or add them to a list of your favourite stations which your radio can access. The radio allows you to store up to 40 presets and as many favourites as you like.

You may search for an Internet radio station by Location. If you know the name of the station and the country from which a station is broadcast this may be the easiest method to find a station. It is also a great way to experience radio from other parts of the world.

You may also search for an Internet radio station by Genre. If you prefer a particular type of music, Blues for example, you may search for a radio station that broadcasts that type of music, and you can choose from a list of Blues radio stations regardless of location, or taking location into account.

If you know part of the name of an Internet radio station, you can enter it into the radio and it will search for stations that match that name. This can be helpful if you are unsure of the location or genre of a particular station.

The STREAM 94i radio connects to a radio station database which serves many users in many countries. This means that there is a very wide range of programme content available. You can also search for stations which have been recently added to those available (new stations) or you can search for the most popular.



Internet radio

Selecting a radio station by location

1. Press **On/Standby** to switch on the radio. Press **Mode** until Internet Radio is selected.
2. Press **Menu**.
3. Choose 'Station list', 'Stations', 'Location', and then scroll the list of continents then countries in either direction. Choose a radio category.

Note that the menu may offer one or more local selections based upon the country in which the radio is being used, according to your internet IP address ('United Kingdom' and 'BBC' stations, for example).

4. Highlight your chosen radio station or Podcast. Press **Tuning**.
If the radio is unable to connect to a particular radio station this may be for one of the reasons explained in 'troubleshooting' page 67.

Selecting a radio station by Genre

1. Press **Menu**. Choose 'Station list', 'Stations', 'Genre', and then scroll the list of content types in either direction. Choose the desired genre.
2. Choose either 'All Stations' or a list of countries.
3. Highlight your chosen radio station. Press **Tuning**.

Searching for a radio station by name

1. Press **Menu**.
2. Choose 'Station list', 'Stations' then 'Search Stations'.
3. To enter the search word(s) rotate **Tuning** to highlight each character for the search in turn, and press **Tuning** to enter. If you make an error rotate the control or use **Info** to access the delete character 'BKSP' on the screen and then press **Tuning**. Rotate the control or press **Info** again to go back to the character selection. After the final character of the search has been entered, use **Info** and then **Tuning** to highlight the 'OK' symbol on the screen and then press the control to finish.

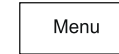

Tuning

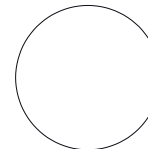

Select/Snooze

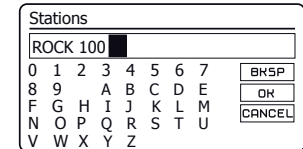
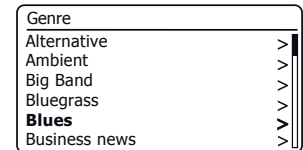
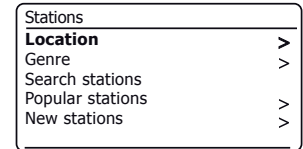
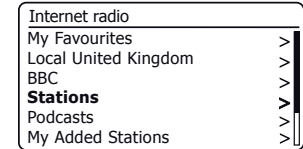
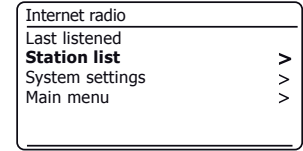

Selecting a new or popular station

Your radio connects via the Internet to a database of radio stations. This option is provided to highlight stations which are newly added to the list of those available, or stations which are particularly popular with listeners around the world.

1. When in Internet Radio mode press **Menu**.
2. Choose '*Station list*', '*Stations*' and then '*Popular stations*' or '*New stations*'.
3. Highlight your chosen radio station. Press **Tuning**.

Selecting a podcast

Radio broadcasters and individuals may make programmes which are intended normally to be downloaded into a computer or copied onto a portable media player. These are commonly known as Podcasts. Podcasts are also accessible using the Podcasts option on the *Stations* menu (see page 22).

1. When in Internet Radio mode press **Menu**. Choose '*Station list*' and then '*Podcasts*'.
2. You may then search by location, genre, or using part of the name of the podcast. The searches operate in exactly the same way as when searching for a conventional radio station.
3. Stations which enable you to listen to previously broadcast programmes may allow you to fast-forward, rewind to any point within a programme and play or pause.

Note: These features are dependent on the programme or podcast and will not always be available.

Last Listened

The 'Last Listened' feature provides you with quick access to the ten most recently listened to radio stations or podcasts. As each new radio station is listened to the oldest item is deleted from the list. The Last Listened list is stored when the radio is disconnected from the mains.

1. When in Internet Radio mode, press **Menu** and then choose '*Last listened*'.
2. The display will then show a list of the last ten Internet radio stations or podcasts. Highlight whichever you wish to listen to and then press **Tuning** to cause your radio to reconnect to that radio station or podcast.

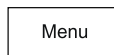

Tuning

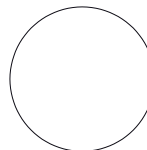

Select/Snooze

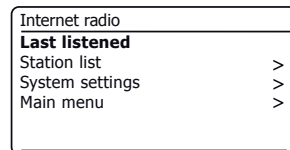
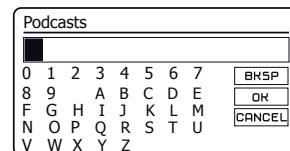
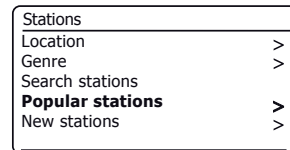

Presetting stations Internet radio, DAB and FM

Your radio has 40 memory presets for Internet radio, 40 DAB and 40 FM which can easily be set to store the details of any radio station or (for internet radio a podcast). The first five presets may generally be accessed using the memory preset buttons 1 - 5, but these buttons are not available when listening to podcasts since they have other functions. In that case the Preset menu should be used instead (see next page). The radio station presets are retained even when the radio is switched off.

For internet radio only, Please see also the sections 'Last Listened' on page 23 and 'Configuring My Favourite Stations' on page 27.

Storing a preset using the preset buttons 1-5

1. Switch on your radio and tune to the required Internet Radio, DAB or FM station.
2. To store the currently playing radio station as a preset, **apply a long press** on the required **Preset** button (1 - 5) until the display shows '*Preset stored*'. The station will be stored using the chosen preset button. Repeat this procedure as needed for the remaining presets.
3. Stations that are already stored in the presets may be over-written by following the procedure described above.



Recalling a preset using preset buttons 1-5

1. Switch on your radio.
2. Select the required mode (Internet Radio, DAB, or FM) using the **Mode** button.
3. Momentarily press the required **Preset** button (1 - 5). Your radio will then connect to the station stored in the preset memory. The preset used will be shown at the bottom of the display screen.

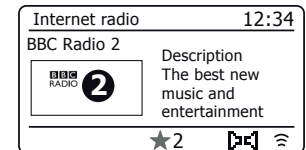
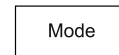

Storing a preset using the menu (presets 1 - 40)

1. Switch on your radio and tune to the required Internet Radio, DAB or FM station.
2. **Apply a long press** on the **Preset** button. The display will show a 'Save to Preset' menu.
3. Use the **Tuning** control to scroll through the preset list until you reach an unused preset or a preset that you wish to change. Press and release the **Tuning** control to store the preset. 'Preset stored' will be shown on the display. Repeat this procedure as needed for the remaining presets.
4. Stations which are already stored in the presets may be over-written by following the procedure above.

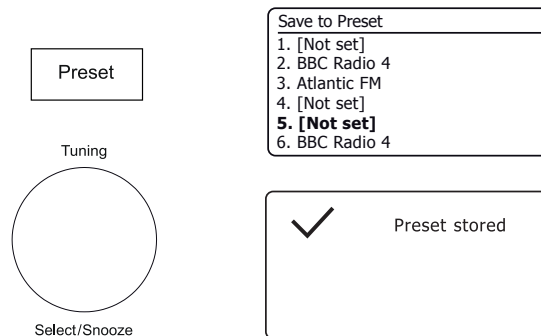

Recalling a preset using the menu (presets 1 - 40)

1. Select the required mode (Internet Radio, DAB or FM) using the **Mode** button.
2. Press and release the **Preset** button to display the 'Recall from Preset' menu.
3. Use the **Tuning** control to select the desired preset station. Press and release the **Tuning** control.

Your radio will then connect to the station stored in the preset memory. The preset used will be shown at the bottom of the display screen.

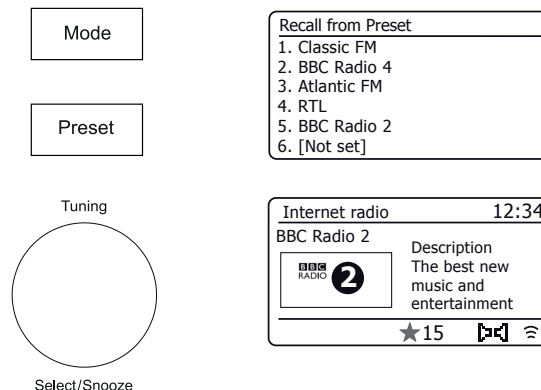

Customising your radio

In addition to storing your favourite internet radio stations in the radio presets, your radio allows you to create customised lists of stations which can appear in two special menus on the radio called '*My Favourites*' and '*My Added Stations*'.

Your radio uses a database which is accessed via the Internet in order to find out which radio stations are available and how it should connect to them. You are able to add your personal selections to this database. These will only be accessible by you using your PC or your radio. You can choose the stations which will appear in the '*My Favourites*' menu from the large selection already listed. Additionally, if you find a radio station that is not listed then you may also add the Internet address (URL) of the station's audio stream to your selection. It will then appear on your radio via the '*My Added Stations*' menu item.

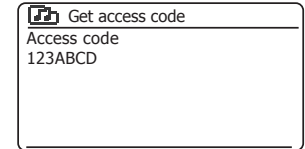
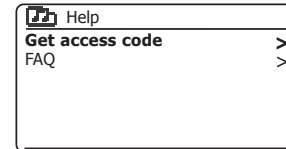
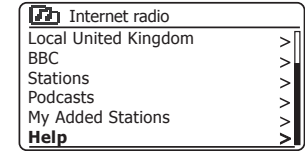
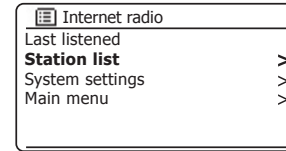

Registering an account

1. Open the web site <http://www.wifiradio-frontier.com> using the Internet browser on your computer. Click on the '*Register here*' link and follow the on-screen instructions to register an account. During the registration process the web site asks for an access code. This allows it to uniquely identify your Internet radio from the many others that it also provides data for. To obtain the access code, please follow these steps.
2. With your radio switched on and in Internet Radio mode, press the **Menu** button, then select '*Station list*' using the **Tuning** control.
3. Scroll down the Station List menu to the item called '*Help*'. Press **Tuning** to enter the Help menu.
4. In the Help menu, select the menu item '*Get access code*'. Provided that the radio is connected to the Internet, a code will be displayed of typically seven characters (upper case letters and numbers). Make a note of this code for the next step. If you need to re-register later you must repeat this process to get a fresh access code.
5. You should then use the code displayed by the radio to fill in the Access Code field on the web page when you set up your account.

Once you have your account set up, if you have other radios which use the same database, you may also add them to your account. You will need to get an access code from each radio in order to add it to the account. They may then share your favourite and added radio station details.

Customising your radio - cont.

Configuring My Favourite Stations

1. Using the web site at <http://www.wifiradio-frontier.com> it is possible to search among the many radio stations that are available by location, genre, or language. You may also choose from new or popular stations.
2. When the radio stations that you have found are shown on your computer screen, they are shown with a 'Play' icon and an 'Add to favourites' icon (the plus symbol and heart). Clicking on the 'Play' icon will allow you to hear the radio station via your computer. Clicking on the 'Add to favourites' icon will cause the radio station to be added to the list accessible via your radio.
3. To help you organise your favourites, and since you may have a great many after a while, the web site will allow you to specify the name for a category or group under which the radio station will be listed on your radio. Suitable names might be 'Rock', 'Smooth', 'Mum's stations', and so on. When ever you add another radio station to your favourites you can either add it to an existing category or create a new one.
4. Once you have Internet radio stations available in your My Favourite Stations list, you may play these stations from your radio. These stations will be available on your radio from the Internet Radio menu item *'My Favourites'*.
5. To look at, modify or delete your favourite stations lists on the web site, use the link *'My favourites'* in the *'My account'* area. To delete a favourite radio station, click on the icon with a heart and minus symbol.

Configuring My Added Stations

1. If you wish to listen to a radio station which is not currently held in the database at <http://www.wifiradio-frontier.com> it is possible to add the details yourself. You will need to obtain the internet address (URL) for the audio stream for the station that you wish to add. This may be information provided by the radio station itself, via its web site, or perhaps passed to you from another listener.
Note: The URL for the audio stream will generally *not* be the URL for the web page from which you listen to the station on your PC.
2. Use the *'My added stations'* link in the *'My account'* area on the web site. This allows you to add details of new stations or to modify those already added. You can provide a name for the radio station which will be shown on your radio. You must also provide the web address, location and format details.
3. Once you have Internet radio stations available in your My Added Stations list, you may play these stations from your radio. These stations will be available on your radio from the Internet Radio menu item *'My Added Stations'*.
4. It is possible to add the web addresses for audio streams which may not be playable by your radio. If you attempt to play such a stream, your radio will normally display an error message of some kind. The Roberts Stream 94i can only play MP3, WMA and AAC Internet radio streams.
5. To look at, modify or delete your added stations list on the web site, use the link *'My added stations'* in the *'My account'* area. To delete an added radio station, click on the icon with a heart and minus symbol.

Storing favourite stations with your radio

It is also possible to store your favourite radio stations whilst playing a station on your radio.

1. Switch on the radio.
2. Tune to the required Internet radio station.
3. **Apply a long press** on **Tuning**. The display will show 'Favourite added'.
4. These stations will be available on your radio from the Internet Radio menu item 'My Favourites', see 'Selecting your favourite stations' below. Repeat this procedure as needed to store other favourite stations.

Selecting your favourite stations

1. When in Internet radio mode press **Menu**.
2. Choose 'Station list' and then 'My Favourites'.
3. Your favourite stations list will appear on the display.
4. Highlight the required station and then press the control to confirm your selection.

Should you be unable to connect to a particular station, please note that some radio stations do not broadcast 24 hours per day, and some stations are not always on-line.

Selecting your added stations

1. When in Internet radio mode press **Menu**.
2. Choose 'Station list' and then 'My Added Stations'.
3. Rotate **Tuning** to highlight the required station and then press the control to confirm your selection. The display will show 'Connecting...' while it finds the new station.

In addition, as mentioned on page 27, it is possible to specify audio streams for 'My added stations' which are not compatible with your radio. In this event the station will not be playable. The Roberts Stream 94i can only play MP3, WMA, and AAC internet radio streams.

Note that the audio coding formats listed are generic terms. There are many variations of each format, as well as a variety of streaming protocols in use by different radio broadcasters. Your radio has been designed to play the vast majority of coding and streaming formats in current use by broadcasters.

Tuning

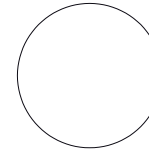

Select/Snooze

Menu

Tuning

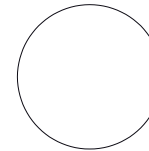

Select/Snooze

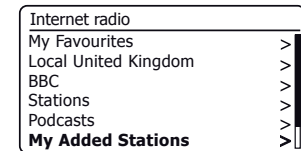
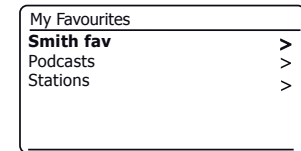
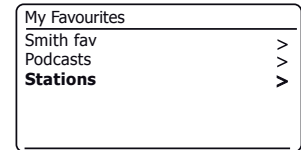
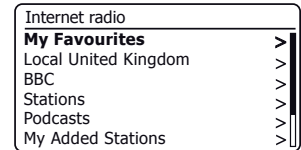

Display options - Radio / Bluetooth / Music Player

Your radio has a range of display options when in Internet Radio, DAB, FM, Bluetooth and Music Player modes:-

1. Press the **Info** button to cycle through the various options.

Internet Radio display options

Description, genre, reliability, format, playback buffer, date.

Additional or alternative information may be displayed when listening to Podcasts.

DAB Radio display options

Station name, scrolling text, program type, multiplex name, channel & frequency, signal strength / error rate, bit rate, audio type and date.

For the signal strength/error rate a low error number indicates a better quality of DAB radio signal. The minimum signal marker 'I' which separates the left and right parts of the signal graph shows the minimum signal level required for satisfactory reception.

If a DAB broadcast provides a slideshow image, this may be viewed full screen by pressing the **Tuning** control. Press the control again to exit.

FM Radio display options

Station name, scrolling text, frequency, program type and date.

In FM mode your radio can use the Radio Data System (RDS) to display the radio station name and additional text when provided by the broadcaster and where the radio signal is sufficiently clear.

Bluetooth display options

If your connected device is able to provide information from the track being played, your radio can display the following in Bluetooth mode:- Title, album and artist details.

Music Player display options

Progress bar, artist, album, format, buffer and date details.

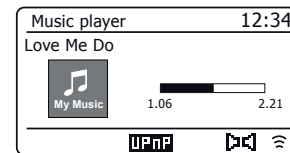
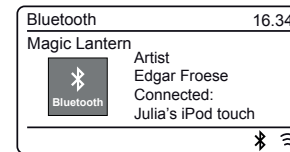
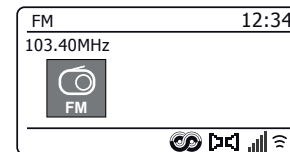
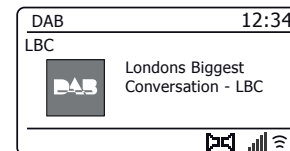
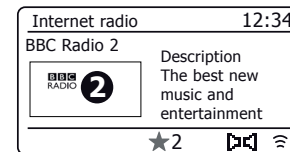
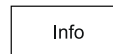

Use with Windows, Apple Mac, Linux, USB memory

The Music Player allows you to play audio files which are stored on a another device connected to your network or which are held on a USB memory device plugged into your radio.

Networked devices that could hold audio files can include computers, smart phones, tablets, Network Attached Storage (NAS) units, and network routers which have UPnP / DLNA file sharing capability. In order to play files from a device on your network, your radio must connect to a file server program on that device which uses the Universal Plug and Play (UPnP) protocol (often known as DLNA).

If the device is a computer or tablet using Windows, then it probably already has a UPnP server program available in the form of Windows Media Player (WMP). This allows you to share your files to devices on your network, and you may then select files by Album, Artist, and so on using your radio's controls. WMP can serve MP3, WMA, AAC and WAV files to your radio (and FLAC files from Windows 10).

If you are an Apple MacOS, Linux, iOS or Android user, or if you have your audio files stored in other formats, such as ALAC, there are many other UPnP server programs available. Note that Apple computers do not support UPnP streaming natively and third party software is required for this task. If you wish to use a DLNA server built into your network router, you should consult your router's documentation on how this should be configured.

The Music Player on the radio can play audio files in MP3, WMA, AAC, ALAC, FLAC and WAV formats. WMA Lossless files can also be played when using Windows Media Player as the UPnP server. Note that the playback of files encoded using WMA Voice, WMA 10 Professional, and of files which have DRM protection is not supported by the radio.



Please note that when using a UPnP/ DLNA server, the search and selection criteria that are available to the user are determined by the server software, and not by the device playing the

content. Typical searches include Artist, Album and Genre. Many server applications also allow you to access your files according to the folders within which they are stored as well as other criteria. Windows Media Player is less flexible than some other UPnP servers in this regard, but is generally easier to set up.

Many UPnP server applications are also capable of sharing pictures and video files to other network connected devices. If this is the case (as it is with Windows Media Player) you may see the option of choosing between 'Music', 'Video' and 'Pictures' on the Music Player's menu. Clearly you should only select the 'Music' option. Content offered via the alternative options will not be playable on your radio.

Some third party server applications allow customisation of the search criteria and indexing methods. This can be useful if you have a very large collection of stored music files.

It is not possible in this book to describe server applications for all available environments, and neither is it practical to describe how to get the best out of each. Windows Media Player is used as an example in this case, although many of the principles are applicable to other servers as well. The access to the media, the choice of media for playing, and the use of the media playback controls from the product or from its controlling app are similar regardless of the UPnP / DLNA server being used.

Accessing your audio files via a UPnP server

If your computer is running Windows 7, 8, 8.1 or 10, then Windows Media Player includes a UPnP server which will make your files available to your radio. There are other UPnP server solutions available for non-Windows users and for Windows users who may wish to use an alternative (see the preceding page).

It is beyond the scope of this instruction book to cover all possible options for UPnP. We explain the use of Microsoft's Windows Media Player here since that will be the first choice for the majority of users.

Set up UPnP access with Windows Media Player

1. At the time of writing, Windows 7, 8, 8.1 and 10 all use Windows Media Player version 12 (referred to here as WMP 12), and the configuration is similar in each case. WMP 12 can create a library from all the media files available to it on your PC. To add new media files to the library, select *'Library'*, then *'Music'*, then *'All music'* or *'Artist'*, *'Album'* etc. This will show you the current library contents. You may then simply drag and drop files from other locations into the library. Alternatively, with media files or folders on the screen, you may right-click on the file or folder and select *'Include in library'* and then select *'Music'*. In this way you can quickly add additional content to your music library.
2. In WMP 12, click on *'Stream'* (see picture at right) and then select *'Automatically allow devices to play my media'*. Then accept the *'Automatically allow all computer and media devices'* option. There are other options (see overleaf) but this is the simplest if you just wish to quickly enable media streaming to your radio.
3. Switch the radio on and press **Mode** until the *'Music Player'* mode is shown. The main music player menu will then be displayed.

Enabling Media Streaming in Windows Media Player 12

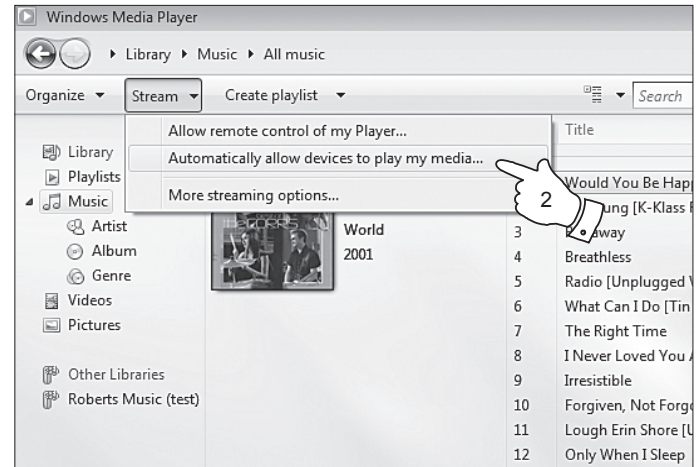

Mode



Music
Player

Set up UPnP access on a Windows PC - cont.

4. Rotate **Tuning** until 'Shared media' is highlighted and press the control to select. The radio will scan for all available UPnP servers. It may take a few seconds for the radio to complete its scan. The radio will display '<Empty>' if no UPnP servers are found.

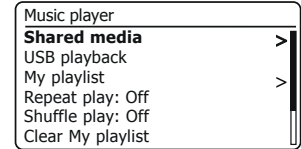
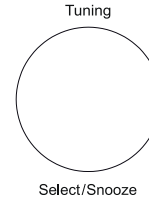

5. After scanning, select your UPnP server using the **Tuning** control. If you allowed automatic connection previously, your radio should now connect and you may skip to the next page. If you did not permit automatic connections, your radio will then normally display 'Unauthorised' at this stage.

6. Your PC may prompt you that there has been a connection to your UPnP server. Whether prompted or not, in order that the radio may access the music files, you will need to click the 'Library' tab in WMP 12 and select the 'Stream...' item to open the 'Media Streaming' window. Select 'Automatically allow devices to play my media' then select 'Automatically allow all computer and media devices'.

Alternatively select 'More Streaming options' to enable sharing on a 'per device' basis.

7. In the 'More streaming options' window, the radio may be listed as a blocked device. Click on the button shown to select 'Allowed'.

Note: If you are using Microsoft's Windows' firewall software, this should be correctly configured by WMP 12. If you are using third party firewall software you may need to manually configure it to allow your unit and WMP 12 to communicate (see the 'Troubleshooting' section on page 67).

8. On the radio, select the named server again using the **Tuning** control. If WMP 12 is now able to communicate with your radio you will be presented with some media selection options on the display.

Allowing a device to connect to Windows Media Player 12

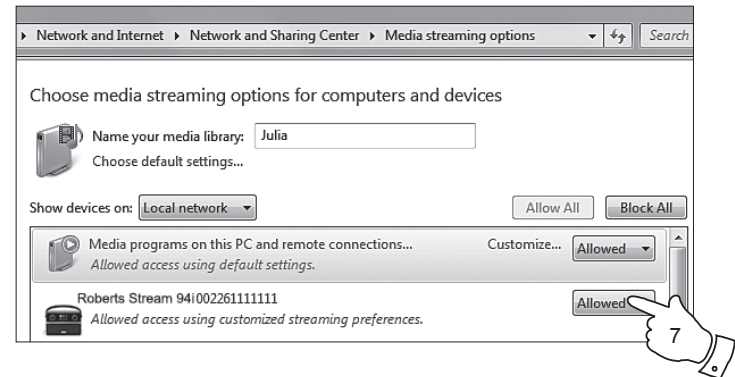

Locating and playing media files using UPnP

Once the UPnP server has been configured to share media files with your radio, you may select the files that you wish to play as follows:-

1. Switch on the radio. Press **Mode** as needed until the *Music Player* mode display is shown. The main Music Player menu will then be displayed.
2. Rotate **Tuning** until '*Shared media*' is highlighted on the display and then press the control to cause the radio to scan for UPnP servers. Note that it may take a few seconds for the radio to complete its scan. The display will return to the Music Player menu if no UPnP servers are found.
3. After a successful scan, rotate **Tuning** to highlight your UPnP server and then press **Tuning**. If the display shows multiple media types, select '*Music*'. (Some UPnP servers can serve pictures and video content to suitable devices.)
4. The radio will now list the media categories which are made available by the UPnP server - for example, '*Album*', '*Artist*' and '*Genre*'. Rotate **Tuning** to highlight which category you wish to browse, then press the control to confirm your choice.

If you wish to use the search function rotate **Tuning** until '*Search*' is selected on the display. You may select characters to build a keyword for searching for content to play.

When you first set up sharing with a UPnP server, not all of your files will be available immediately. The UPnP server must look inside each file to identify the artist and album information from 'tags' embedded in them. The server may also need time to access the Internet to obtain additional information such as 'album art' which it can display when you examine your music library on your PC. For a library of many files this can take some time.

Media selection

When searching via UPnP you will have a selection of search criteria as determined by the UPnP server software on your computer. This allows you to search by a given information type (Album, Artist, Genre, etc.) and then to narrow the search to an album or to a particular track within an album.

Some UPnP server applications allow the search options to be customised. The searches described here are just examples of the possibilities.

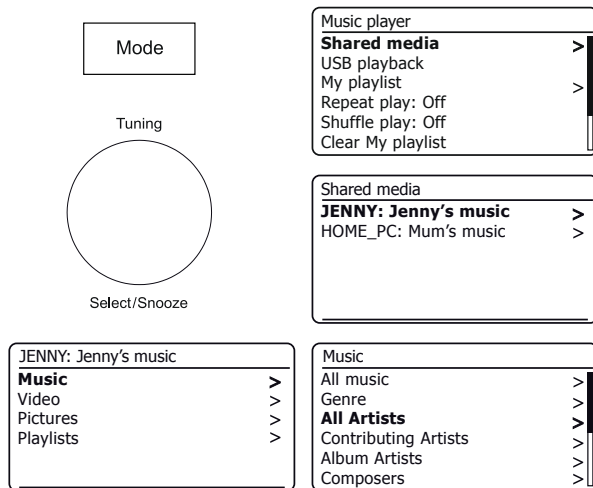

The Stream 94i is able to display the album art for the track being played. The ability of the radio to display art depends on the presence of the art in the file being played, the art being not too large (or being re-sized by the server), and the ability of the UPnP server to send the art to the radio. Art sent to the radio needs to be in a JPEG format and no larger than 640 x 480 pixels. If the radio does not receive any art then a default icon is displayed. Some UPnP server applications will also send a default icon if no art is found within the file being played. Due to the wide variations in album art formats and UPnP/DLNA standards, the failure of the radio to display album art is not considered to be a fault.

Listening to a complete album

1. Use the **Tuning** control to choose content by Artist, Album, Genre, etc. according to your needs then press the control to enter your choice.
2. When you reach the album or folder the menu will then switch to showing the tracks in that album or folder. When searching by UPnP they will normally be listed in track number order (but as with the search criteria, this can vary according to the server application used).
3. With the first track in the album indicated, press **Tuning**. The album will then begin playing.

While the radio is playing from your media library, you may use the menus as described to choose a different selection. When you select the track from which to play, the radio will then immediately begin playing the new selection. Please also see 'Playlists' on page 38.

Listening to a particular track

1. If you wish to play only a particular track from an album or folder, first choose the album or folder as described on the preceding pages.
2. Rotate **Tuning** until the required track is highlighted.
3. Press **Tuning**. The track will begin playing. The radio will then play subsequent tracks from the same album or folder.

Controlling playback

1. Press **Pause** to pause playback of the current track.
2. If you press **Play**, playback will resume from the point where it was paused.
3. Press **Rewind** to start playback of the previous track in the list.
4. Press **Fast-forward** to start playback of the next track in the list.
5. Press and hold the **Fast-forward** or **Rewind** button to move through the current track. The longer the button is pressed, the greater the speed at which the player will move through the track. Release the button when the desired point is reached. (Note that this feature is not supported when playing files encoded using the FLAC and ALAC formats.)
6. Press **Stop** to stop playback. Press **Play** to resume playback.

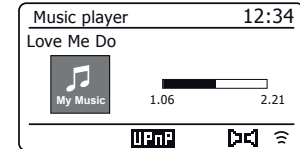
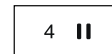
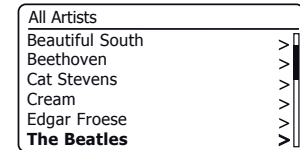
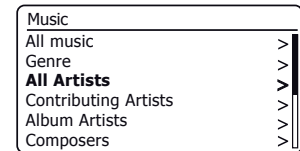
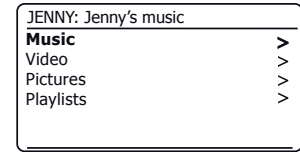
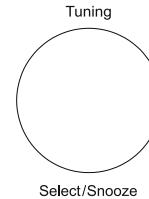

Controlling playback cont.

In the music player you may choose to repeat the current album (or playlist), or to play the files in random order, or both options together.

Repeat tracks

1. To enable or disable the Repeat option, press the **Preset** button. The **Repeat** icon will show on the display when Repeat is enabled.

You may also control the option from the Main Music Player menu.

2. Rotate **Tuning** until 'Repeat play' is highlighted.
3. To activate the repeat option press **Tuning** so that 'On' appears on the display. Your selected tracks will now be played repeatedly.
4. To turn off the repeat option highlight 'Repeat play' and press **Tuning** so that 'Off' appears on the display.
5. Press **Menu** to exit.

Play tracks in random order

1. To enable or disable the Shuffle option, **apply a long press** on the **Preset** button. The **Shuffle** icon will show on the display when Shuffle is enabled.

You may also control the option from the Main Music Player menu.

2. Rotate **Tuning** until 'Shuffle play' is highlighted.
3. To activate the shuffle option press **Tuning** so that 'On' appears on the display. Your selected tracks will be played in random order.
4. To turn off the shuffle option highlight 'Shuffle play' and press **Tuning** so that 'Off' appears on the display.
5. Press **Menu** to exit.

If both Repeat and Shuffle playback options are set to 'On' then both Repeat and Shuffle icons will be shown in the display.

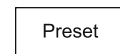

Tuning

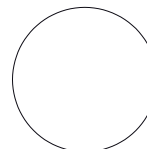

Select/Snooze

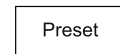
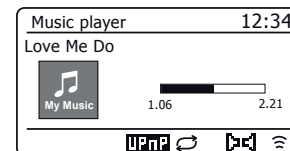
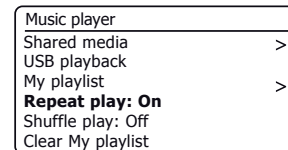

Tuning

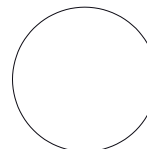

Select/Snooze

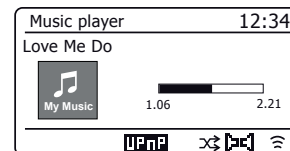
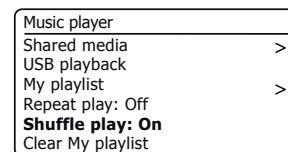

Using USB memory devices

This section describes how to use your radio to access and playback your audio files via USB memory devices. USB memory devices plug into the rectangular slot on the back of the radio.

Important: Your radio is only designed to work with USB flash memory devices. It is not intended to be connected to hard disk drives or any other type of USB device.

The Stream 94i radio has been tested with a range of USB memory devices of up to 256GB capacity. USB memory must use the FAT or FAT 32 filing system in order to operate with your radio. Your radio is unable to play from media formatted using the exFAT or NTFS formats.

It is possible to use SD, SDHC or SDXC cards for media storage and playback when held in a suitable USB adaptor. However, due to the wide variation of such adaptors, it is not possible to guarantee that all adaptor / card combinations will work in the radio.

Audio formats supported are MP3, WMA, AAC, FLAC, ALAC and WAV.

USB playback does not support files encoded using WMA Lossless, WMA Voice, WMA 10 Professional, nor files of any format which have DRM protection.

Recommendations:

Unless you have only a few files on the USB memory device, do not place all files in the root folder.

The number of items (files / sub-folders) in any folder should be less than 2000.

Searching and playback will be more responsive if the number of files in any one folder is limited (we suggest not more than 250).

It is recommended that the USB memory is reformatted in your computer before adding your music files.

The maximum depth of folder nesting permitted is 8 folder levels (but playback is only from the currently selected level).

Shuffle and Playlist functions are limited to 500 tracks.

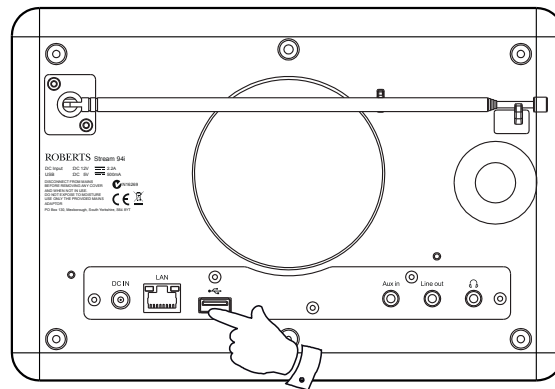

Cautions:

In order to minimise the risk of damage to your radio or your USB memory, please place the unit so that the memory device cannot easily be knocked while it is inserted in the socket.

Remove the USB memory before carrying the unit or if not using the USB feature for a prolonged period.

Place the unit in Standby mode before removing your USB memory device.

The USB connection is intended only for flash memory devices. The use of hard disk storage media is not supported.

Playback via USB of files stored on MP3 players is not guaranteed.

Playing files from USB memory devices

1. Carefully insert the USB memory device into the USB socket at the back of the radio. Press **On/Standby** to switch the unit on.

The radio may detect that the memory has been connected, in which case it will ask whether you wish to open the folder view of the memory contents. Press **Tuning** to select 'Yes' and skip to step 4 below.

If the USB memory was not automatically detected, proceed as follows.

2. To select USB playback mode press **Mode** as needed until the *Music Player* mode is selected.

3. Rotate **Tuning** until '*USB playback*' is highlighted on the display and press the control. The radio will now list the content stored on the USB memory device. If there are many files or folders this may take a few seconds.

4. Rotate **Tuning** to highlight the required folder and press the control to enter the current folder. The list of tracks in the current folder will be displayed.

Alternatively, if you have nested folders (such as album folders within an artist folder) then you will simply step to the next folder level.

5. Rotate **Tuning** to select the track and press the control to begin playing from the highlighted track. All files in the current folder will then be played in turn.

Files are sorted by filename in numeric-alpha order (0 - 9 ... A - Z) before being played. Albums will play in the correct order if the filename begins with the track number (use leading zeroes if more than 9 tracks).

6. Controlling playback from the USB memory device including Shuffle and Repeat functions is explained on page 34-35.

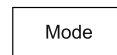

Tuning

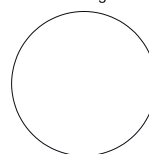

Select/Snooze

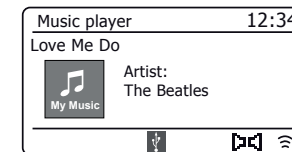
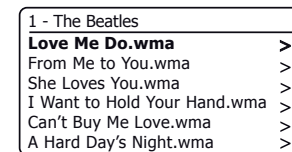
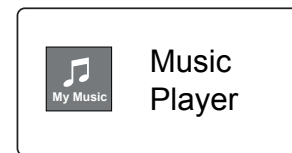

Playlists

You may wish to set up a list of music tracks or albums which can then be played as background music for a party, for example. Your radio can be configured to hold a queue of up to 500 tracks in a playlist menu. The tracks or albums for the playlist can be selected from your UPnP server and from a USB memory device. The playlist is held in the memory in your radio until the external power is removed, or until the playlist is cleared from the menu.

Adding a single track, entire album or folder to your playlist

1. When selecting (or when playing) a track using a UPnP server or a USB memory device **apply a long press** on the **Tuning** control and the display will show 'Added to My playlist'.
2. The track will be added to the playlist for playback later.
3. When using a UPnP server or a USB memory device highlight the chosen album, artist or folder and **apply a long press** on **Tuning**. The display will show 'Added to My playlist'.
4. Each of the tracks within the album, artist or folder selection will be added to the playlist individually. This allows any unwanted tracks to be removed from the playlist if needed (see below).

Viewing your playlist

1. Press **Mode** as needed until the *Music Player* mode is shown. The Music Player menu will then be shown on the display.
2. Choose 'My Playlist' to enter the playlist.
3. Rotate **Tuning** to scroll through the playlist. Tracks which are served via UPnP will show their track name and USB tracks will show their file name.

Erasing a track from the playlist

1. Press **Menu** and then choose 'My Playlist'.
2. Rotate **Tuning** until the track you wish to erase is highlighted. **Apply a long press** on **Tuning**.
3. To delete the track rotate **Tuning** until 'YES' is highlighted, then press the control to confirm the deletion. If you do not wish to delete the track from the list rotate **Tuning** to highlight 'NO' and press the control to cancel the operation.

Music Player

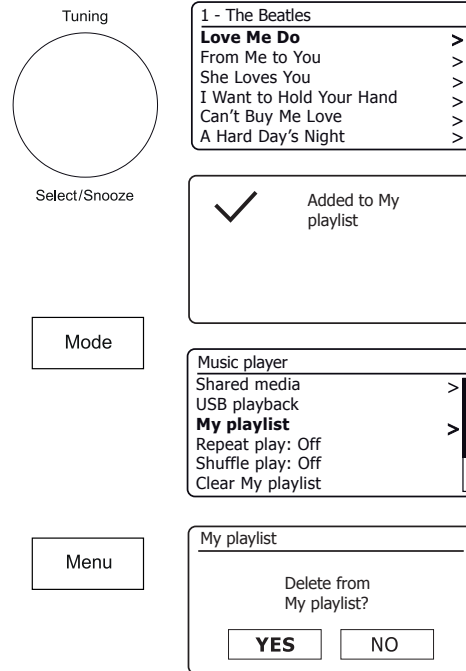

Clearing the playlist

1. Press **Menu**. To clear the whole playlist choose '*Clear My playlist*' and then choose 'YES'. If you do not wish to clear the playlist choose 'NO'.

Playing your playlists

1. Press **Menu**. Choose '*My playlist*'.
2. To play the playlist from a particular track, rotate **Tuning** until the desired track is highlighted then press the control to start play.
3. While playing from the playlist, you can use this function to jump to a particular track within the playlist. While playing from the playlist, you may add additional tracks or albums or remove specific tracks (please see the preceding page).

Prune servers

Your radio stores details of UPnP servers that it has seen via its network connection in its internal memory. If you use the radio at different locations you may find that there are servers listed by the radio that you are no longer interested in. The prune servers function allows only active UPnP servers on the currently connected network to be shown when selecting 'Shared Media' from the Music Player menu.

1. Press **Menu**. Choose '*Prune servers*'. To remove servers that are no longer required choose 'YES'. If you do not wish to prune servers choose 'NO'.

Wake On LAN

If you are using a computer as a UPnP server for playing your music files via your radio, you may not wish to keep that computer operating when you are not listening via your radio. If your computer is suitably configured, it can either shut down, or enter a Standby or hibernation state when it is not being used.

Your radio can wake up a computer which has shut down using a Wake On LAN command via the network provided that the radio has previously connected to a UPnP server application on that computer. A computer which is not currently active will be shown with a question mark in the list of UPnP servers. Many computers will not respond to Wake On LAN commands from the radio in all modes, and may require software, device driver, BIOS, hardware or router configuration changes for this function to operate. Failure of a computer to respond to Wake On LAN is not considered a fault of the radio.

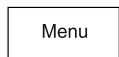

Tuning

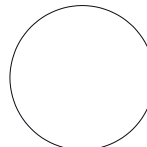

Select/Snooze

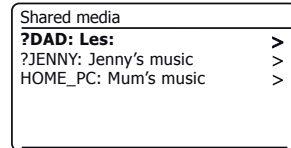
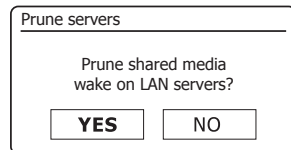
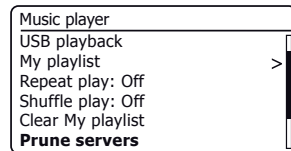
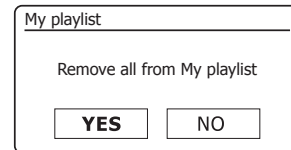
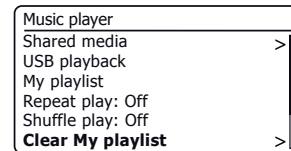

Your radio has the option to shut down its WiFi or Ethernet connection when it is in Standby. This minimises power consumption but it does mean that you will need to switch the radio on manually in order to use either Spotify Connect, the 'Play to / Cast to Device' function or any remote control software such as the UNDOK app.

If you need to be able to remotely control the radio even when it has been put into Standby, then you can choose to keep the network connected by using the '*Keep network connected*' option in the network settings menu. In the Standby mode display the WiFi signal indicator is shown with or without a cross through it, or the Ethernet connection indicator is shown unplugged or plugged in, according to the state of the connection.

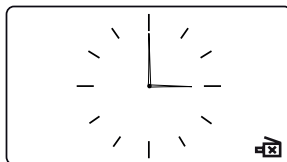
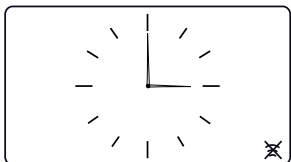
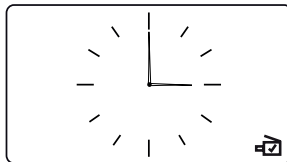
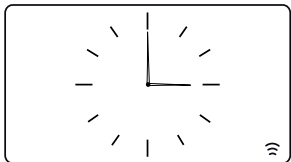
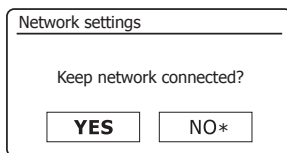
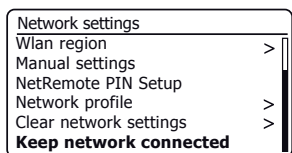

Windows 'Play to' / 'Cast to Device' function

If you use Windows 7, 8, 8.1 or 10 it is possible to choose a music album, track or playlist at the computer and then tell Windows that this should be played on the radio using the 'Play to' function (called 'Cast to Device' in Windows 10).

Similar functionality is available for handheld devices using Apple's iOS or Android operating systems by using the UNDOK app. To use this feature, choose the 'Local Music' source option in the UNDOK app.

When used in this way the playing screen on the radio will show the current operating mode as 'Local Music'. In this mode the radio operates as a DLNA Digital Media Renderer.

1. In order to use the 'Play to' / 'Cast to Device' function, the radio must be actively connected to the network. If your radio is configured to keep its network connection in Standby mode (see 'Keep network connected', at left), then go to step 3.
2. If your radio is not currently in use, or does not have an active connection to your network, then you should first switch on your radio and select the Music player mode using the **Mode** button. Then select 'Shared media' from the menu so that the radio establishes a connection with Windows Media Player on your PC. After this step, all other functions may be performed from your computer.
3. At your Windows PC, locate the file, album or playlist that you wish to play on the radio.
4. Use the right-hand mouse button to pop-up a menu of options for the chosen item and select the 'Play to' / 'Cast to Device' option.
5. Windows should show you one or more devices, including your radio, to which you may choose to send the music. Highlight the radio item and click with the left mouse button.

6. Windows will then open a 'Play to' / 'Cast to Device' window showing the track or tracks to be played. Your computer will then take control of your radio. Your radio will enter the 'Local Music' mode and after a few seconds the radio will start playing.

7. While the radio is playing in 'Local Music' mode you can use the controls in the 'Play to' / 'Cast to Device' window on your computer to skip tracks, fast-forward or rewind, to pause or restart, and to change the volume on the radio.

You may also use the controls on your radio to adjust volume, display track information (press the **Info** button) or to change operating mode. It is not possible to skip tracks or pause playback using the radio's controls while it is in 'Local Music' mode.

8. While playing, you may select additional content within Windows and again use the 'Play to' / 'Cast to Device' function (see steps 3 – 5). The additional tracks will be added to the playlist in the current 'Play to' / 'Cast to Device' window. You may also delete or change the order of tracks within the 'Play to' / 'Cast to Device' window.

9. When you wish to exit 'Local Music' mode, simply either switch off your radio or select a different operating mode.

Don't forget that in order to reselect the 'Local Music' mode and to be able to use 'Play to' / 'Cast to Device' from Windows you must first ensure that your radio has an active connection to your network (see steps 1 and 2 above).

Note: Some Windows security software can prevent correct operation of the 'Play to' / 'Cast to Device' function. Such software may have updates or configuration options which will permit 'Play to' / 'Cast to Device' to operate correctly - please consult your anti-virus software supplier. The 'Play to' / 'Cast to Device' function in Windows 7, 8, 8.1 and 10 has been tested successfully with the Stream 94i radio when using Microsoft's own security software without problems.

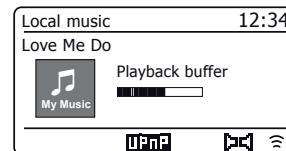
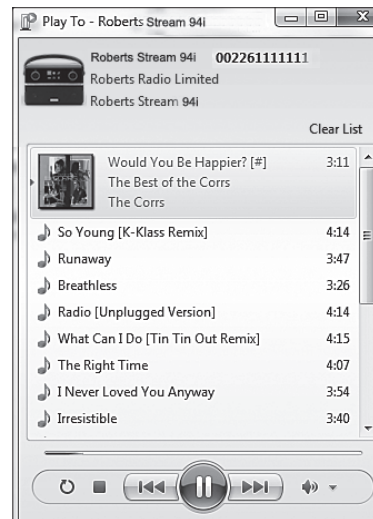

Spotify Connect - the basics

Spotify is all the music you'll ever need. Millions of songs available instantly. Just search for the music you love, or let Spotify play you something great. Spotify works on your phone, tablet, computer and home speakers. So you'll always have the perfect soundtrack for whatever you're doing.

Spotify Connect allows your Spotify selections to be played through the radio, remotely controlled from your iPhone, iPad, Android device or any Desktop.

Spotify Connect also allows you to transfer the playing of the sound to other Spotify Connect enabled devices under the control of your smart-phone, tablet or any Desktop

Once your Spotify account has been connected to your radio, you may start Spotify playing from the radio without needing to use the Spotify app.

Spotify Connect compatibility is shown with the following identifier:



Setting up Spotify Connect

For more details about setting up Spotify Connect, please go to [spotify.com/connect](https://www.spotify.com/connect)

To use Spotify with your Stream 94i radio you will need to download the Spotify app and you will need a **Spotify Premium** account.

The Spotify software is subject to third party licenses found here: www.spotify.com/connect/third-party-licenses

Using Spotify Connect

1. Add your radio to your network using WiFi or Ethernet, see '*Configuration*', page 9.
2. Fire up the Spotify app on your phone, tablet or PC using the same network as above.
3. Play a song on Spotify and hit '*Devices available*'.
4. Choose your radio and your music will start playing out loud.

More complete instructions for using Spotify Connect with the radio are given on the following pages.

Playing music using Spotify Connect

Spotify Connect lets you push a button to control the music between your Spotify Connect enabled devices. While playing a song, you can switch playback from your smart-phone, tablet, Desktop or even to a Connect enabled radio.

1. If you have selected *'Keep network connected'* in the network settings menu (see page 40), Spotify Connect will be able to access your radio even if your radio is in the Standby mode.
- If you have not selected *'Keep network connected'* you will have to switch the radio on manually and select Internet Radio mode in order to cause your radio to connect to the network.
2. Make sure that both your radio and Apple iOS / Android device are connected to the same network and that you have downloaded the latest Spotify app on your device.
3. Simply open the Spotify app on your Apple iOS / Android device and choose a track or playlist. When the Spotify app has identified other devices that are compatible with Spotify Connect, the **Spotify Connect icon** (🔊) will be shown with the text *'Devices available'*.

Tap the **Spotify Connect icon** (🔊) or the *'Devices available'* text to show a list of Spotify Connect enabled devices to which you can transfer the playing of the music.

4. To select your radio choose **Stream 94i** on the Spotify Connect devices screen. You are now ready to play music through your radio using Spotify Connect. The Spotify app will also allow remote control of the volume and track selection.

The next time you open Spotify, it will continue playing from the previously selected device.

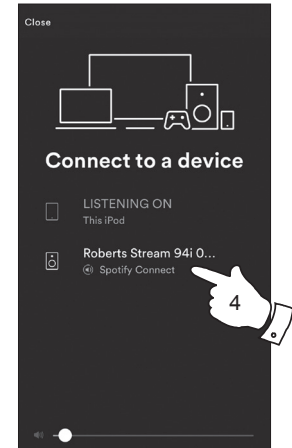
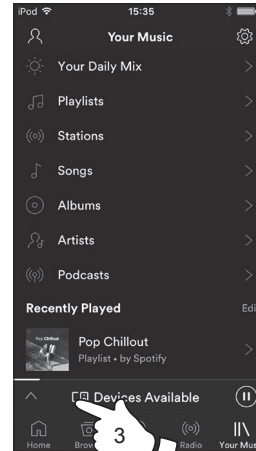

Note: On some devices the layout of controls within the Spotify app may be different from that shown and may also change with different versions of the app. Refer to spotify.com/connect if needed.

Controlling Spotify on your radio

The music can be controlled using the controls on your radio as well as by any Spotify enabled device.

1. Press the **Pause** button to pause playback of the current track.
2. Press the **Play** button, playback will resume from the point where it was paused.
3. Press the **Forward** button to start playback of the next track in the current Spotify playlist.
4. Press the **Rewind** button to start playback of the previous track in the current Spotify playlist.
5. Rotate the **Volume** control to set the required volume level. The volume may also be controlled from within the current Spotify app.
6. Press the **Info** button to step through the available display options.

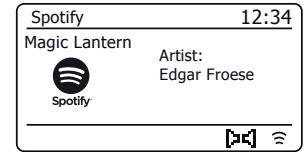
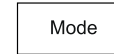
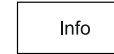

Using the Mode button to select Spotify

If you have previously connected using the Spotify Connect app you may select Spotify using the mode button on your radio.

1. Press the **Mode** button to select the Spotify mode.

Please note if the power is removed you will need to re-connect Spotify with your radio using the app once again.



Friendly name - Spotify Connect

Your radio is identified within the Spotify app using its Friendly Name. By default, your radio's name will be shown as "Stream 94i" followed by a 12 digit alphanumeric code which is the network MAC address that is unique to your radio.

If you would like to change this name to something more personalised you may follow the instructions on page 65 of this instruction book.

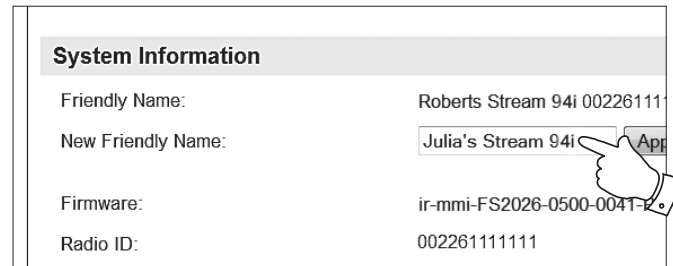

DAB Radio

1. Carefully extend the telescopic aerial. Press **On/Standby** to switch on the radio. If the radio has been used before the last used mode will be selected.
2. Press **Mode** as needed to select the DAB Radio mode.
3. If this is the first time that the DAB mode is used a scan of the Band III DAB channels will be carried out. The display will show 'Scanning'. During the scanning process, as new stations are detected the station counter will increase and the stations will be added to the list which is stored in the radio. The bar graph indicates the progress of the scan. When scanning is completed the radio will list the stations found (in numeric-alpha order 0....9...A...Z), unless it has previously tuned to a DAB station.
4. Rotate **Tuning** to scroll through the list of available DAB radio stations.
Press **Tuning** to select the highlighted station. The display may show 'Connecting...' while the radio re-tunes. Use the **Volume** control to set the sound level as needed.
5. If the station list is still empty after the scan the display will show 'Service not available'. If no stations are found it may be necessary to relocate your radio to a position giving better reception.

Selecting a DAB radio station

1. When playing a DAB radio station, rotate **Tuning** to access the radio station list and to scroll through the available stations.
2. Press **Tuning**. The display may show 'Connecting...' while the radio re-tunes.

Note: A question-mark in front of the station name indicates that the station has not recently been detected by the radio.

The use of the radio station presets is described on page 24.

Secondary services

Some radio stations may have one or more additional broadcasts associated with them. If these are available, they will appear immediately after the main station as you rotate the **Tuning** control clockwise. To tune to the selected service, press **Tuning**.

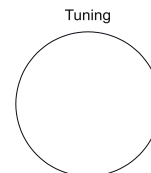
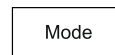
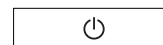

Select/Snooze

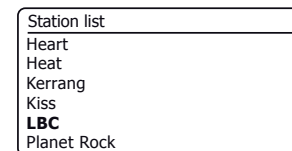
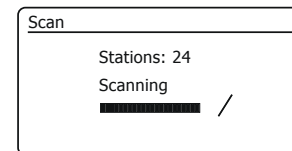
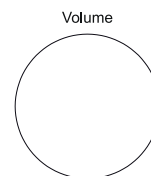

Finding new DAB radio stations

Should you wish to use your radio for DAB reception in a new location, or if no stations were detected during the initial scan, you can follow this procedure to allow your radio to find out which DAB radio stations are available.

1. Press **Mode** as needed to select the DAB Radio mode.
2. Press **Menu**.
3. Choose 'Scan'.
4. Press **Tuning**. The display will show 'Scanning' and your radio will perform a scan of the Band III DAB frequencies. As new stations are found the station counter will increase and stations will be added to the list. The bar graph indicates the progress of the scan.

Manual Tuning

Manual tuning allows you to tune your radio to a particular DAB frequency in Band III. Any new stations found will be added to the station list. This function can also be used to assist the positioning of the telescopic aerial or the radio to optimise reception for a specific channel or frequency.

1. When in DAB mode, press **Menu**.
2. Choose 'Manual tune'.
3. Choose the required DAB channel. Press **Tuning**.

When the radio has tuned, the display shows the channel number and frequency, and the name of the DAB multiplex found (if any). A bar graph shows the signal strength and is useful if you need to reposition the radio or its aerial. The minimum signal marker 'I' which separates the left and right parts of the signal graph shows the minimum signal level required for satisfactory reception. Any new radio stations found on the tuned DAB multiplex will be added to the list stored in the radio.

4. Press **Menu** or **Back** to choose a different frequency.
5. Press **Menu** or **Back** a second time to access the main DAB menu then select 'Station list' to return to normal tuning.

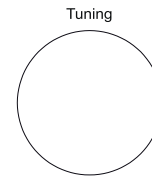
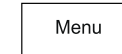
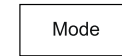

Select/Snooze

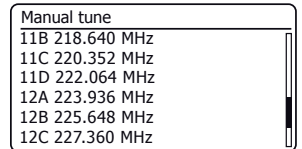
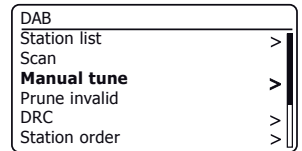
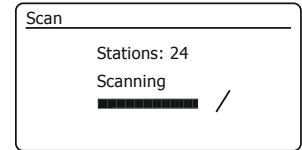
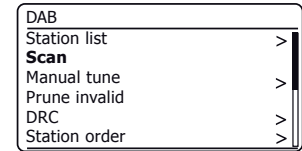
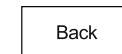
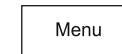

Dynamic Range Control settings

The DRC facility can make quieter sounds easier to hear when your radio is used in a noisy environment.

1. When in DAB mode, press **Menu**.
2. Choose 'DRC' and then choose the required DRC setting (default is Off).
DRC Off - DRC is switched off, Broadcast DRC will be ignored. DRC Low - DRC level is set to 1/2 that sent by broadcaster. DRC High - DRC is set as sent by broadcaster.
3. Press **Tuning** to confirm the setting. **Note:** Not all DAB broadcasts use the DRC function. If the broadcast does not provide DRC information, then the DRC setting in the radio will have no effect.

Station order setup

Your radio has 3 station order settings from which you can choose. The station order settings are, alphanumeric, ensemble and valid. **Note:** The default station order on your radio is alphanumeric.

1. When in DAB mode, press **Menu**.
2. Choose 'Station order' and then choose 'Alphanumeric' (list alphabetically), 'Ensemble' (organised by DAB multiplex) or 'Valid' (shows only those stations for which a signal can be found).

Prune stations

If you move to a different part of the country, some of the stations which were listed may no longer be available. Also, from time to time, some DAB services may stop broadcasting, or may change location or frequency. Stations which cannot be found, or which have not been received for a very long time are shown in the station list with a question mark. The Prune stations function will delete the marked DAB stations from your station list.

1. When in DAB mode, press **Menu**.
2. Choose 'Prune Invalid' and then choose 'YES' to cause the invalid station names to be removed from the station list. If you do not wish to prune stations choose 'NO'.

Note: If you have moved your radio to a different part of the country you should also carry out a search for new stations (please see the section 'Finding new stations' on page 46).

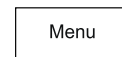

Tuning

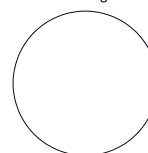

Select/Snooze

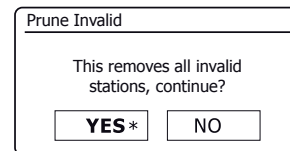
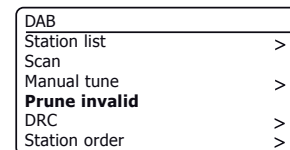
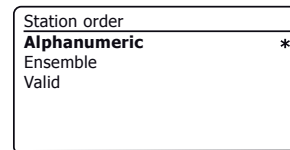
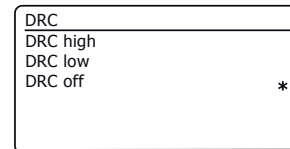
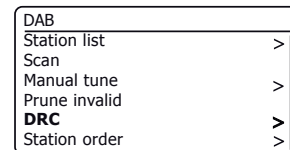

FM Radio

Operating your radio in FM mode

1. Carefully extend the telescopic aerial and press **On/Standby** to switch on the radio.
2. Press **Mode** as needed to select the FM Radio mode.
3. Rotate **Tuning** in a clockwise direction. The displayed frequency will increase. Press **Tuning** to carry out an auto-tune. Your radio will scan up the FM band from the currently displayed frequency and will stop scanning when it finds a station of sufficient strength.
4. The display will show the frequency of the signal which has been found. If RDS information is available, after a few seconds the display will show the radio station name.
If you only hear hiss or interference, simply press **Tuning** to scan further. Your radio may have found a spurious interference signal.
5. To find more FM stations press **Tuning** to repeat the scan operation. To scan down in frequency, rotate **Tuning** in an anti-clockwise direction first and then press the control. Your radio will scan down the FM band from the currently displayed frequency and will stop scanning when it finds a signal of sufficient strength.
6. When the end of the waveband is reached your radio will recommence tuning from the opposite end of the waveband.
7. Use the **Volume** control to adjust the sound level as needed.

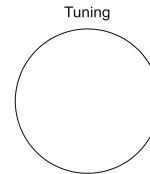
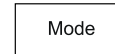
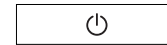

Select/Snooze

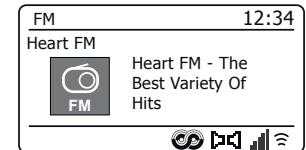
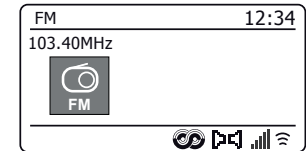
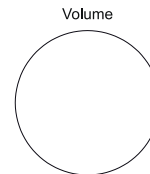

Manual tuning

1. Rotate **Tuning** to tune to a station. The frequency will change in steps of 50kHz.
2. Adjust the volume.

Scan sensitivity setting - FM

Your radio will normally scan for FM broadcasts which are strong enough to give good reception. However, you may wish the Auto-scan function to also be able to find weaker signals, possibly from more distant radio transmitters. Your radio includes a local / distant option for the Auto-scan function.

1. When in FM mode, press **Menu**.
2. Choose 'Scan setting'.
3. To set your radio so that only the stations with the strongest signals are found during scanning choose 'YES'. (Normally this will restrict scanning to local transmissions).
4. Alternatively, to set your radio so that all available stations are found during scanning (local and distant transmissions) choose 'NO'.

Note: The initial setting (out of the box, or after a System Reset) causes the radio to ignore weaker (or more distant) signals.

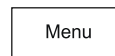

Tuning

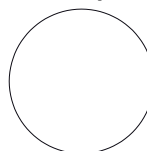

Select/Snooze

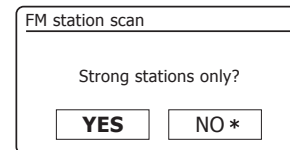
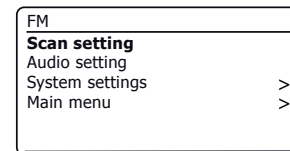

Stereo / Mono switching - FM

Your radio will play stereo FM broadcasts in stereo provided that the received signal is of adequate strength. However, as a stereo signal becomes weaker the audio signal will become poorer.

It may be preferable to force the radio to play the station in mono in order to reduce the level of background hiss.

1. Ensure your radio is in FM mode and tune to the required FM station.
2. To change the audio setting, press **Menu**.
3. Choose 'Audio setting'. The current audio setting is indicated with an asterisk. To switch to mono in order to reduce the hiss from a weak FM signal choose 'YES' or choose 'NO' to return to the normal automatic 'stereo or mono' setting.

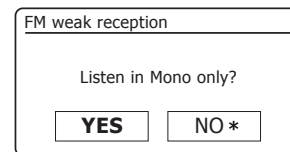
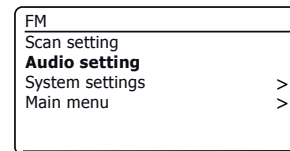

The Bluetooth mode on your radio allows you to play audio, play sound from video files and stream music from Bluetooth capable devices such as your mobile phone, computer, tablet etc. through your radio's loudspeakers.

- When a Bluetooth enabled device such as your Stream 94i Radio is in a 'discoverable' state other Bluetooth devices can detect, pair with or connect to it.
- 'Bluetooth pairing' occurs when two Bluetooth enabled devices agree to establish a connection and communicate with each other.

Connecting Bluetooth devices

1. Ensure that the Bluetooth capability on your phone, tablet or PC is enabled. You may need to refer to the user documentation for your device, since the method will vary with each device.
2. Ensure your radio is switched on.
3. Press the **Mode** button on your radio until the Bluetooth mode is selected. Your radio will show that it is 'discoverable' and the **Bluetooth indicator** will flash blue on the display. If the indicator is blue and not flashing, then the radio is already connected to another device. To cause the radio to become 'discoverable', press **Menu** and then choose 'Setup Bluetooth'. Press **Tuning**. Your Stream 94i will become discoverable by other devices.
4. Using the Bluetooth settings of your phone, tablet or PC direct it to search for 'discoverable' devices. After a few seconds, you should see a device named 'Stream 94i'. Just occasionally it may take longer for the radio to be found by your device.
5. Select 'Stream 94i' to cause your phone, tablet or PC to pair with your radio and to establish a connection.
6. Once the connection is established the Bluetooth indicator will remain steady. You can now begin playing music from your smart-phone, tablet, etc.

Some Bluetooth devices may require a 'Passkey' (an authentication key) in order to establish a link between devices. A passkey is similar to a password, although you only need to use the passkey once to establish a link. If your device asks for a passkey to be able to pair with your radio then enter a code of 0000 (four zeroes).

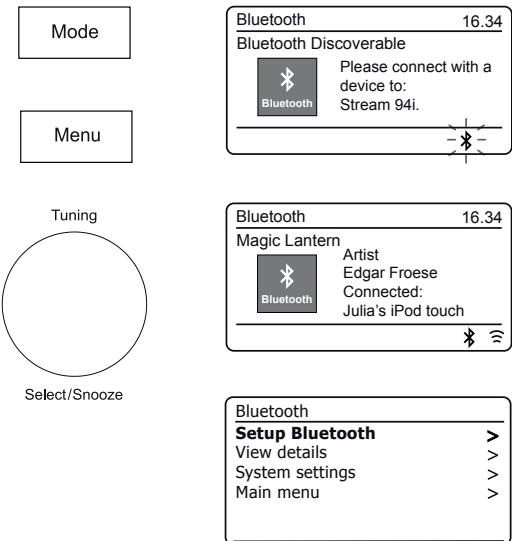

Playing audio files in Bluetooth mode

When you have successfully connected your radio with your chosen Bluetooth device you can start to play your music using the controls on the device.

1. Once playing has started adjust the volume to the required setting using the **Volume** control on your radio or the connected Bluetooth device.
2. The volume of your radio in Bluetooth mode is affected by the volume settings on the radio and also on the connected Bluetooth device.

If you adjust the volume control on the radio but you find that the volume from the radio is not sufficient, it may be that the volume setting of the connected device needs to be increased.

3. The audio player in your phone, tablet or PC may be able to respond to the **Play**, **Pause**, **Next** track, **Previous** track buttons on the radio.

Note: Not all player applications or devices may respond to all of these buttons.

Connecting and reconnecting a Bluetooth device

You can only have one Bluetooth device connected to the radio at any one time although it may be paired with several devices. Once you have a Bluetooth enabled device connected to your radio it cannot be interrupted by another Bluetooth device unless you choose to break the connection.

1. To connect to a different device, press **Menu** and then choose 'Setup Bluetooth'. Press **Tuning**. The **Bluetooth indicator** flashes blue.
2. Your Stream 94i radio will become 'discoverable' by other devices.
3. You can now pair the radio with a new device using its Bluetooth settings the radio will be listed as 'Stream 94i'. When the new Bluetooth connection has been established the **Bluetooth indicator** will remain steady. You may then play music from the new device through the radio.
4. If you no longer want your Bluetooth device to be paired with your radio you will need to delete the 'Stream 94i' pairing on the device. Please refer to the device's Bluetooth documentation.

Volume

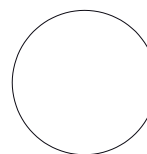

5 ▶

4 ||

2 ▶▶

1 ◀◀

Menu

Tuning

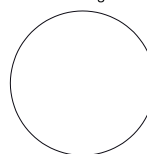

Select/Snooze

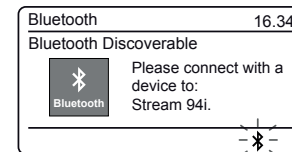
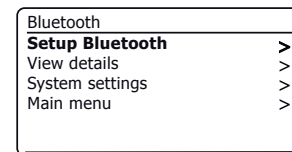
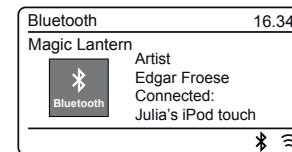

View Bluetooth information

1. To view the Bluetooth information of the currently connected Bluetooth device, press **Menu** and then choose 'View details' and then 'Bluetooth Info'.

The Bluetooth information including Bluetooth status and friendly name will be displayed.

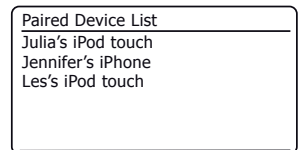
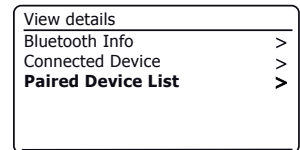
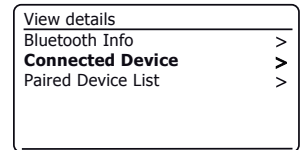
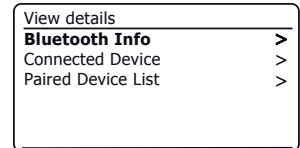
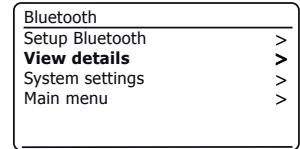
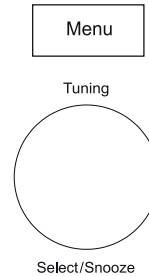

View Bluetooth connection details

1. To view the details of the currently connected Bluetooth device, press **Menu** and then choose 'View details' and then 'Connected Device'.

View Paired Device list

1. To view the paired device list, press **Menu** and then choose 'View details' and then 'Paired Device List'.
2. The radio will display a list of up to 8 previously connected devices.

Bluetooth information

Bluetooth connectivity performance may vary depending on the connected Bluetooth devices. Please refer to the Bluetooth capabilities of your device before connecting to your radio. All features may not be supported on some paired Bluetooth devices.

A Bluetooth connection can provide a link for audio up to a distance of approximately ten metres. When pairing two Bluetooth enabled devices, for convenience, we recommend they should be no more than 2 to 3 metres apart. The presence of other functioning Bluetooth devices during connection may lead to operational difficulties.

Bluetooth is a short-range radio communication system and generally Bluetooth devices can communicate with each other clearly within a regular sized room or office. The reliability of a Bluetooth connection between different rooms will greatly depend upon the construction of the building.

Bluetooth communication range may be substantially reduced if the signal passes through a solid object. Human bodies, brick and concrete walls, heavy furniture or bookcases will all reduce the operational range of your Bluetooth devices to a greater or lesser extent. Glass, dry-wall or wood paneled walls and office partitions may have a less severe but noticeable effect. Metal pipes, foil-lined plasterboard, metal window frames and domestic wiring can also have an effect. You should position your Bluetooth devices closer to each other if you observe communication difficulties.

WiFi networks and cordless phones generally use similar radio frequencies to Bluetooth and may interfere with one another. If any interference is noticed, then try relocating the radio or one of the other devices.

The Bluetooth capabilities of your radio enable it to receive audio from many Bluetooth capable devices including mobile phones, personal computers and tablets. Only one Bluetooth device can be connected to your radio at a time. It supports the following Bluetooth profiles and functionality.

- Your radio supports A2DP (Advanced Audio Distribution Profile) which is a stereo audio connection that streams stereo music from PCs, mobile phones etc. SBC and AAC audio codecs are supported.
- Your radio supports AVRCP (Audio Video Remote Control Profile) which allows your radio to control music playback from the connected device.

Note: Some mobile phones may temporarily disconnect from your radio when you make or receive calls. Some devices may temporarily mute their Bluetooth audio streaming when they receive text messages, emails or for other reasons unrelated to audio streaming. Such behaviour is a function of the connected device and does not indicate a fault with your radio.

Note: If the unit is in the Bluetooth mode and it is not connected to a Bluetooth device for more than 15 minutes it will automatically switch to the standby mode. The LCD will revert to the standby mode clock display. To use the radio again, simply press the On/Standby button to switch it on.

Clock and Alarms

Automatically updating the clock

Your radio will normally update the clock automatically when connected to the internet. If you enter a time setting manually, the radio will calculate a local time offset which is then stored in memory. Whenever it synchronises the clock using the internet, including after a power failure, your radio will then set the clock automatically using this information.

Alternatively you may specify that the time is not automatically updated. In this case the clock must always be set manually after a power interruption.

1. With your radio switched on, press **Menu**.
2. Choose 'System settings', 'Time/Date', 'Auto update' and then choose an update option from 'Update from Radio', 'Update from Network' or 'No update' as required.

Setting the clock format

The clock display used in Standby mode and on the playing mode screens can be set to 12 or 24 hour format. The selected format is then also used when setting the alarms.

1. With your radio switched on, press **Menu**.
2. Choose 'System settings', 'Time/Date', 'Set format' and then select either 12 or 24 hour. The current clock display format is marked with an asterisk.

If the 12 hour clock format is chosen, the radio will then use the 12 hour clock for the setting of alarms, and will display a 12 hour clock with an AM or PM indicator when in standby mode.

Clock and Alarms

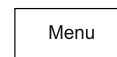

Tuning

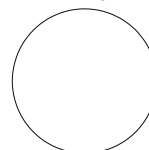

Select/Snooze

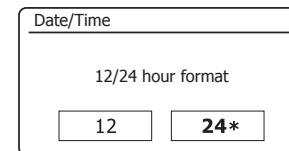
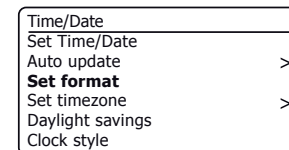
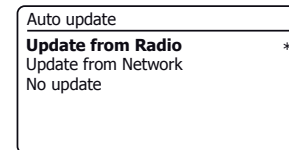
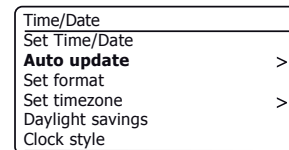
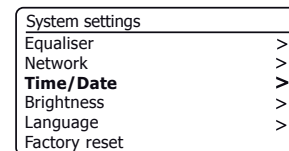

Manually setting the clock

After a connection to the Internet has been established, your radio will normally set its clock automatically to the local time zone that was specified during setup (see page 10). Should you need to set the time manually, change the time zone, or manually switch from winter to summer time (from GMT to BST in the UK, also commonly known outside the UK as daylight savings time), then please follow this procedure.

1. With your radio switched on, press **Menu**.
2. Choose '*System settings*'.
3. To change the current time or date setting choose '*Time/Date*', '*Set Time/Date*', and then set the correct day, month, year, hour and minute digits.
To change the time zone setting go to step 5.
To change from winter to summer time go to step 6.
4. The display will then return to the previous menu.
5. Select '*Set timezone*' and choose the time zone which is applicable to your location.
6. Select '*Daylight savings*'. The asterisk shows the current setting.
In the UK, ON is equivalent to British Summer Time, OFF is equivalent to Greenwich Mean Time.
7. Choose '*ON*' or '*OFF*' as required. Press **Menu** to exit.

Clock style

Your radio's standby display can be set to the analogue or digital clock style.

1. With your radio switched on, press **Menu**.
2. Choose '*System settings*', '*Time/Date*' and then '*Clock style*'.
3. To select the digital clock style choose '*Digital*' or to select the analogue clock style choose '*Analogue*'. The current style will become visible when the radio is put into standby.

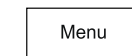

Tuning

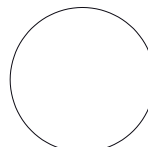

Select/Snooze

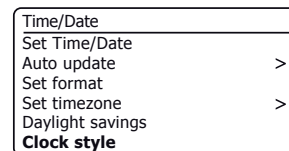
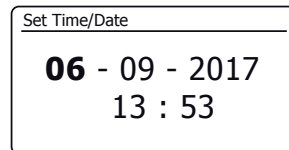
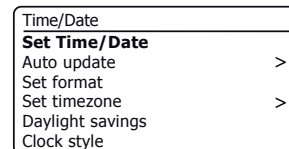
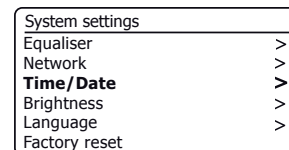

Setting the alarm clock

Your radio has two separate alarms which can be set to wake you to either the radio or a buzzer alarm. In the event of a power interruption your radio has built in memory that will retain your alarm settings. Ensure that the time is set correctly before setting the alarms.

Alarms may be set while the radio is in standby mode or switched on.

1. To change the states of the alarms while the radio is in *Standby* press the **Alarm** button. The display will cycle through No Alarm, Alarm 1 enabled, Alarm 2 enabled or Alarms 1 and 2 enabled.
2. To change the alarm settings *while the radio is in Standby*, **apply a long press** on the **Alarm** button. This will cause the Alarms menu to be displayed. Then skip to step 5 below.
3. To change the alarm settings *while the radio is switched on*, either press and release the **Alarm** button and then skip to step 5 below, or alternatively press **Menu**. Choose '*Main menu*'.
4. Choose '*Alarms*' the current alarm settings will be displayed. If no change is required, press the **Menu** or **Back** buttons to exit.
5. Choose alarm (1 or 2).
6. Choose '*Time*' and then choose the alarm hour and then the alarm minute. If the radio has been set to use a 12 hour clock format, there will also be an option here for setting AM or PM for the alarm time.
7. The display will then return to the alarm setting menu.
8. Choose '*Enable*'. The display will show the Frequency options for the alarm. The alarm frequency options are as follows:

'*Off*' - the alarm will be disabled

'*Daily*' - the alarm will sound everyday

'*Once*' - the alarm will sound once

'*Weekends*' - the alarm will sound only at weekends

'*Weekdays*' - the alarm will sound on weekdays only

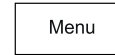
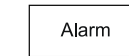

Tuning

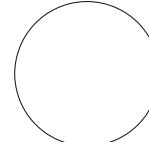

Select/Snooze

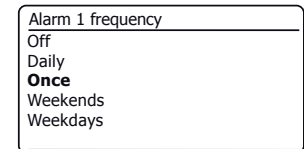
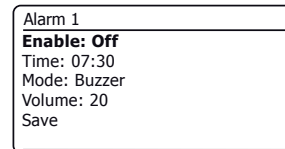
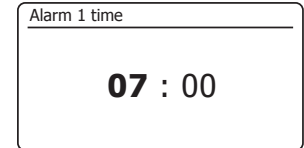
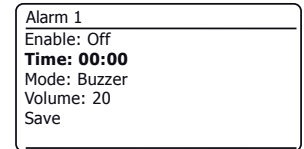
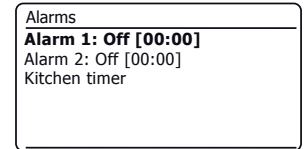
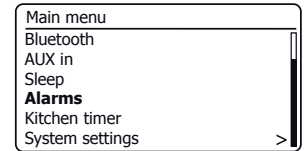

Setting the alarm clock - cont.

- Choose the alarm frequency option. Choosing Off will disable the alarm.
If you choose to set the alarm to Once you will also need to set the date.
- The alarm can be set to buzzer, Internet radio, DAB radio or FM radio. For whichever radio mode is selected, the radio alarm may be set to any of the stations which have been stored as presets or to the station most recently listened to.

Choose the *'Mode'* option for the alarm either *'Buzzer'* or the required radio mode.

- If setting the alarm to a radio option, choose the *'Preset'* option.

Choose from either the radio station *'Last listened'* to, or from the presets 1 - 40. Scroll to the chosen option and press the control to confirm the selection.

Note: The alarm may only use a preset which has already been stored.

- Choose the *'Volume'* option. The radio uses the saved volume setting for each alarm when it sounds. Use the **Tuning** control to set the required volume setting.
- In order to store the alarm settings select the *'Save'* option. Press **Tuning**. Your radio will show *'Alarm saved'* and will then go back to the list of alarms with the new alarm setting shown in the display.

If you decide not to save the settings, press **Back**. The display will show *'Save changes'* with a *'YES'* or *'NO'* option. Choose *'NO'*. *'Alarm not saved'* will show on the display.

Active alarms are shown using small alarm indicators on the playing displays and on the clock display when in Standby. **Note:** If you make a mistake, use the **Back** button to go back to the previous screen.

When the alarm sounds

The buzzer or radio alarm will sound at the selected times for up to 60 minutes unless cancelled. The volume used for the alarm will be as specified during the alarm setting procedure. If the radio cannot connect to the specified DAB radio station, the buzzer alarm will be used instead.

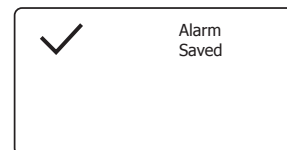
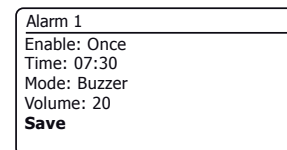
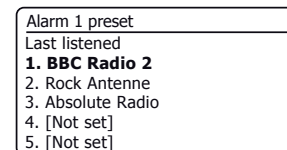
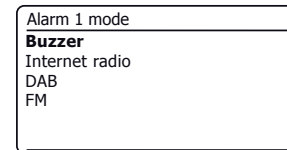
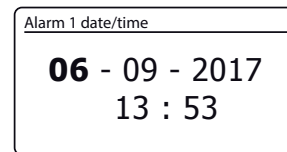
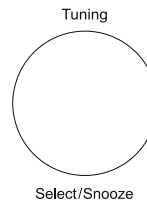

When the alarm sounds cont.

1. During an alarm, the alarm icon will flash on the display. The radio will automatically revert to standby mode after 60 minutes.
2. To cancel an alarm, press **On/Standby** to return to Standby mode.

Note: If the radio is switched on because of an alarm you can control basic functions such as volume and selecting presets. You cannot perform operations which involve the **Tuning/Select** control since this also acts as the Snooze button (see below).

Snooze timer

1. The buzzer or radio alarm can be silenced for 5 minutes by pressing the **Tuning/Select/Snooze** control. Should you wish for a longer snooze duration this can be extended. Pressing the control again while the radio is snoozed will set the available snooze time to 5, 10, 15 or 30 minutes.
2. While the snooze timer is active the remaining snooze time is shown next to the flashing alarm icon on the clock display.
3. In order to cancel the Snooze timer while the alarm is suspended, press **On/Standby**. The display will briefly show an 'Alarm Off' message.

Disabling alarms

1. To disable an alarm while the radio is in standby mode press and release the **Alarm** button to cycle through the alarm on-off options (see page 56, step 1).
2. To disable an alarm while the radio is playing enter the Alarms menu (see page 56, steps 3 and 4) and select alarm (1 or 2).
3. Choose 'Enable' and choose the 'Off' option.
4. Choose the 'Save' option and press **Tuning** to save the new setting.
The chosen alarm will now be disabled.

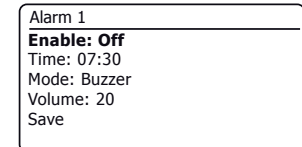
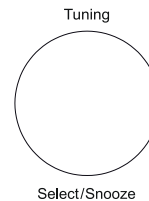
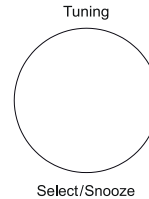
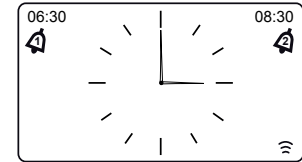
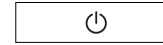

Sleep timer

Your radio can be set to turn off after a preset time has elapsed. The sleep timer can be set while the radio is in Standby or whilst in use. The sleep timer setting can be adjusted between 5 and 120 minutes in 5 minute increments.

1. **Apply a long press** on the **On/Standby** button to access the sleep timer. Select the required sleep time. The sleep timer can be set to between 5 and 120 minutes, or to Off. Press **Tuning** to confirm.
2. If the radio was in standby the radio will then be switched on for the chosen duration. If the radio was already playing then it will continue playing and the sleep timer will be set to the chosen duration. An active sleep timer is shown using a small timer indicator at the bottom of the playing displays. This indicator also shows the sleep time remaining before the radio switches itself into Standby mode.
3. To set the sleep time using the menu, press **Menu** and then choose 'Main menu', 'Sleep' and then the required sleep time. Press **Tuning** to confirm the setting.
4. To cancel the sleep time before the preset time has elapsed and to turn off the radio, press **On/Standby** to turn the unit off manually. To cancel the sleep timer and leave the radio playing, go back into the sleep timer settings (steps 1 above) and select the Off option.

Kitchen timer

The Kitchen Timer allows you to set the radio to alert you after a pre-determined interval (up to 5 hours in 1 minute increments). The kitchen timer can be set while the radio is in Standby or whilst in use.

1. To change the kitchen timer settings while the radio is in standby, **apply a long press** on the **Alarm** button. If the radio is in use, press the **Alarm** button. This will cause the Alarms menu to be displayed. Then skip to step 3 below.
2. To access the kitchen timer using the menu, press **Menu** and then choose 'Main menu'.
3. Choose 'Kitchen Timer' and then the required kitchen timer setting. The kitchen timer can be set to between 1 and 300 minutes, or to Off.
4. An active kitchen timer  is shown on the display. The indicator also shows the time remaining. When the selected time has elapsed, the buzzer will sound.
5. To cancel the buzzer when it sounds press **On/Standby** or choose Off in the timer settings.

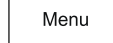
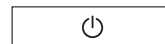

Tuning

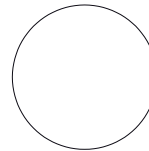

Select/Snooze

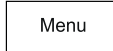

Tuning

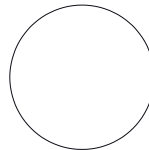

Select/Snooze

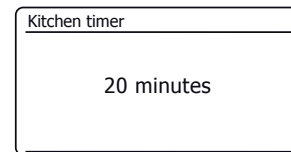
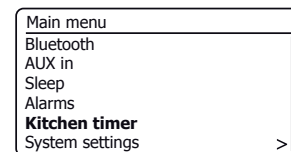
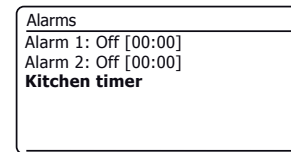
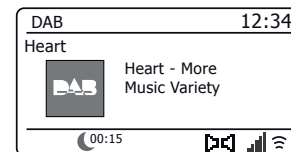
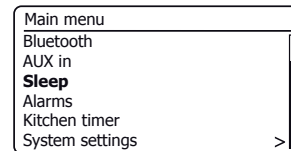
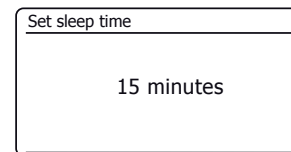

Equaliser function

The sound on your radio can be adjusted to suit your personal taste for the material that you are listening to. The Stream 94i has a range of equaliser modes. Alternatively you may set the treble and bass levels to your own preferences which can be accessed from the *My EQ* menu item.

1. With your radio switched on, press **Menu**.
2. Choose '*System settings*', '*Equaliser*' and then cycle through and highlight the various mode. Press **Tuning** to confirm your selection.

'*Normal*', '*Jazz*', '*Rock*', '*Movie*', '*Classic*', '*Pop*', '*News*', '*My EQ*'

The currently selected mode is marked with an asterisk.

Setting up your My EQ profile

If you find the preset equaliser functions not to your liking, you may set up a custom treble and bass setting as follows:

1. Follow steps above in order to enter the Equaliser menu.
2. Choose '*My EQ profile setup*' then '*Bass or Treble*'.
3. Choose the desired level (between -14 and +14). The sound will change as you turn the tuning control. Press the control when you are happy with the bass or treble setting.
4. Press **Back** and the display will prompt you to save the changes. If you wish to save the changes choose '*YES*'. If you do not wish to save the changes choose '*NO*'. Press **Tuning**.
5. To use the '*My EQ*' profile choose '*My EQ*'.

To quickly cancel the effect of the '*My EQ*' profile choose '*Normal*'.

The treble and bass settings will be remembered for the next time that you wish to use the '*My EQ*' setting. The Loudness setting in the *My EQ* profile enables a brighter sound with an enhanced stereo image. It is switched off by default.

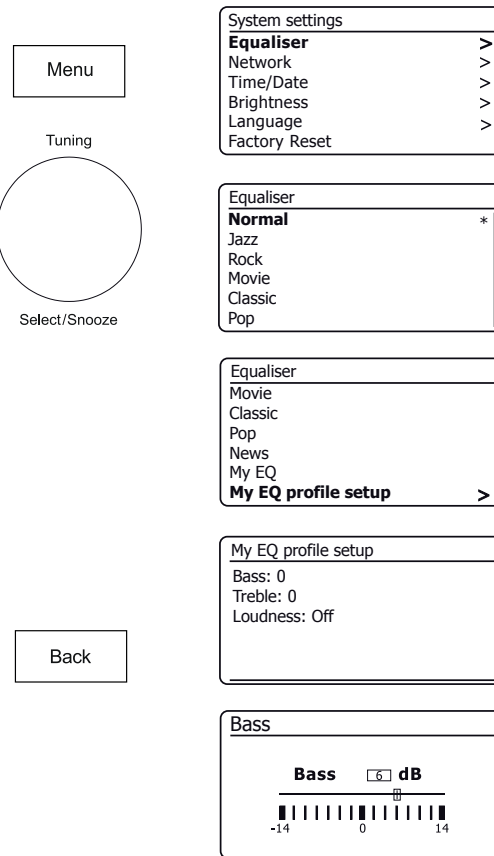

Brightness control

The brightness of the display can be adjusted for when the radio is in standby and for when it is in use. If you use the unit in the bedroom, you may prefer a lower standby brightness level than the standard setting. There are 6 Standby brightness levels and 6 levels for when the radio is in use. To change the current brightness setting please follow these steps.

1. **Apply a long press** on the **Info** button to access the display brightness setting.
2. Choose either the High, Medium High, Medium, Medium Low, Low or Off brightness level. Press the **Tuning** control to set the level. If the radio is playing, then the chosen brightness will be applied immediately. If the radio is in standby, then the chosen brightness will be applied after a 10 second delay.
3. To set the display brightness using the menu press **Menu**.
4. Choose 'System settings' and then 'Brightness'.
5. To adjust the display brightness when the radio is switched on select 'Normal'.
To adjust the display brightness when the radio is in standby select 'Standby'.
Press **Tuning**. The current setting will be marked with an asterisk.
6. Choose either the High, Medium High, Medium, Medium Low, Low or Off brightness level. Press the control to set the level. Press the **Menu** button to exit.

When the radio is in Standby mode, pressing a button or turning a rotary control will cause the radio to switch to the high brightness level for a few seconds. This is so that even if the standby brightness level is set low, it is still possible to see the time when needed.

Headphone socket

A 3.5mm **Headphone Socket** located on the rear of your radio is provided for use with headphones. Inserting a plug automatically mutes the internal loudspeaker. Please be aware that the sensitivity of headphones can vary widely. We therefore recommend setting volume to a low level before connecting headphones to the radio. **IMPORTANT:** Excessive sound pressure from earphones and headphones can cause hearing loss.



To prevent possible hearing damage, do not listen at high volume levels for long periods.

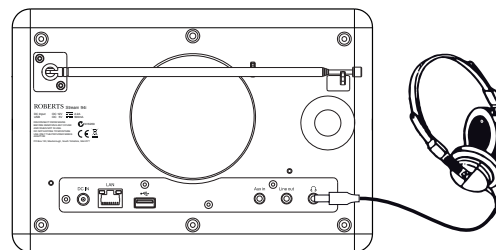
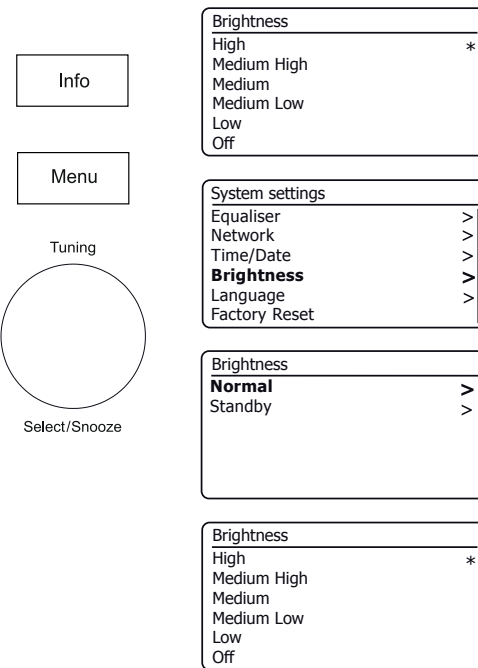

Line out socket (3.5mm Jack)

A 3.5mm **Line Out** socket located on the rear of your radio is provided for connecting the audio signal to an external amplifier. Inserting an audio cable into this socket will not mute the internal loudspeaker. Set the volume control on the radio to minimum if desired.

Auxiliary input socket

A 3.5mm **Auxiliary Input** socket located on the rear of your radio is provided for connecting the audio signal from an external audio source such as an MP3 or CD player.

1. Connect a stereo lead from the headphone output of your MP3 or CD player to the Aux In socket located at the rear of the radio. Typically this lead will have a 3.5mm stereo plug at both ends.
2. Switch on your radio and press the **Mode** button until **AUX in** mode is shown on the display.
3. Press 'play' on the connected audio device. If you are using its headphone output for the connection, set its volume control to a level of somewhere between two-thirds and maximum (the objective is to get a strong audio signal but without too much distortion). Then adjust the volume on the radio as required.

Note, if using an iPod as the sound source, you may need to set its output to maximum to get an adequate audio signal level.

4. After use, disconnect your player in order to listen to your radio conventionally.

Inactive Standby feature

In order to minimise its energy consumption when not in use, your radio includes an automatic Inactive Standby feature. This is designed to put your radio into standby if it detects that it is no longer being used in the following circumstances.

Internet radio – streaming is stopped; Music player – music playing is stopped;

Spotify Connect – streaming is stopped; Aux-in / Bluetooth – there is no audio input signal

If any of these conditions is detected for more than 10 minutes then the radio will start a 5 minute countdown before entering standby. The display will show the time remaining. After 15 minutes of inactivity the radio will enter standby with the clock being displayed.

Pressing any button or resuming listening during the 15 minute period will reset the standby timer.

Display and Audio

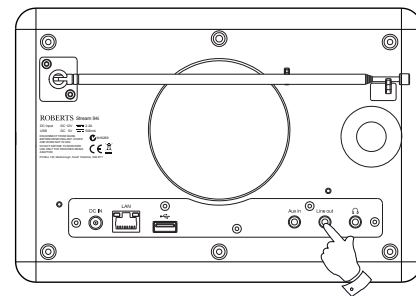

Mode

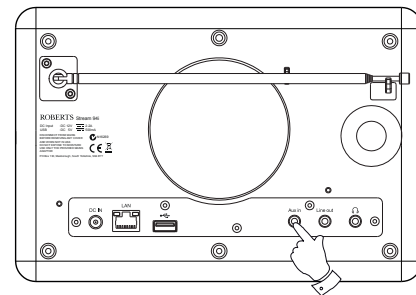

Standby in 5 minutes
Please press
any button to cancel.

Information

Factory reset

If you wish to completely reset your radio to its initial state this may be performed by following this procedure. By performing a factory reset, all user entered settings will be erased.

1. With your radio switched on, Press **Menu**.
2. Choose 'Main menu', 'System settings', 'Factory Reset' and then 'YES' to proceed.

If you do not wish to carry out a system reset, highlight 'NO' and then press the control. The display will revert to the previous menu.

3. With 'YES' highlighted, press **Tuning**. A full reset will be performed and the radio will restart as if first plugged in. The DAB stations list together with any preset stations will be erased and your wireless network connection details will be lost. All configuration settings will be restored to their defaults, the clock and alarms will be reset.

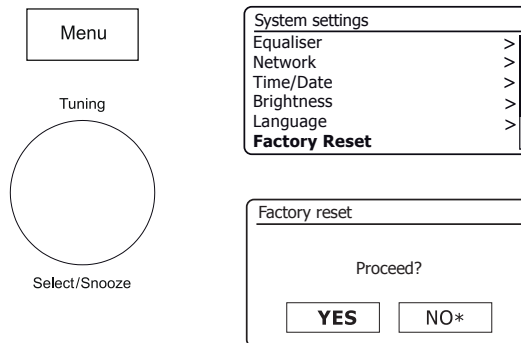



Electro-magnetic compatibility advice

In the event of a malfunction due to electrostatic discharge, mains power supply transients or short interruptions, reset the product as above to resume normal operation. If you are not able to perform the reset operation as above, removal and reconnection of the power supply may be required.

If the product is used in an environment with any ESD Immunity / Radiated Immunity / Conducted Immunity disturbance, the product may malfunction. It will automatically recover to normal when the ESD Immunity / Radiated Immunity / Conducted Immunity disturbance is stopped.

When connecting the radio to a router with an Ethernet cable, shielded cable is highly recommended. The communication could be interrupted temporarily or noise may occur if using un-shielded cable and under strong local interference (between 43 and 80MHz). Normal communication will resume automatically when the interference signal is removed. FM radio reception may also benefit from the use of a shielded cable.

Product markings

	DC Voltage Power input 12V / 2.2A USB output 5V / 500mA
	Recycling This product bears the selective sorting symbol for Waste Electrical and Electronic Equipment (WEEE). This means that this product must be handled pursuant to European directive 2012/19/EU in order to be recycled or dismantled to minimize its impact on the environment. The user has the choice to give the product to a competent recycling organization or to the retailer when buying a new electrical or electronic equipment.

Software update

From time to time, new software features for your radio may be developed. Your radio has therefore been designed to allow its internal software to be updated using your Internet connection. You should not attempt to update your radio unless it is recommended to you by Roberts Customer Services. Updating the software may remove all network settings, radio station presets and alarm settings from your radio. It is important that you do not attempt this procedure unless you have a good Internet connection and a reliable mains power supply. If the radio connects to your router using a WiFi connection, make sure that this is also reliable before proceeding.

1. The 'Software update' option is accessed via the System Settings menu. When you select 'Software update' the menu will display 'Auto check setting' and 'Check now'. If you want your radio to check periodically for new software versions choose 'Auto check settings' and then choose 'YES'. If you do not want your radio to check for updates choose 'NO'.
2. To check if there are any software updates available currently, choose 'Check now'. The radio will check to see if an update is available. The display will show 'Checking for new versions'. If there are no updates then the display will show 'Software up to date'. If a software update is available your radio will then offer the choice of updating the software or not, displaying 'New version available. Update software?'. Select the 'YES' option if you wish to go through the update process. If you choose to update your radio it will first download the new software and will then reprogram its internal memory. This may take anything from a few seconds to a few minutes depending on the speed of your internet connection.
3. Once the software update is completed, the radio will prompt you to press **Select** to restart. Press **Tuning** and your radio will then restart. You may find that you will need to reconfigure your network connection following an update. You may also need to re-enter all radio station presets, alarm settings, and configuration options.

VERY IMPORTANT: Do not switch off the power to the radio until the update operation is complete and the radio has restarted, otherwise the unit may become permanently damaged.

Network profiles

Each time that you connect your radio to a WiFi network, the radio will store the details of that connection (SSID, security key, DHCP/IP address settings) as a profile. Up to four such profiles are stored in the radio so that if the unit is used in multiple locations there is no need to enter the network settings when returning to a location previously visited. The radio stores the four most recent profiles in memory identified by their SSID. Normally the radio will attempt to connect to one of the stored profiles and only if it is unable to do so will you need to use the Network Wizard (see page 15).

In the event that you visit a location only once you may wish to delete the profile for the network in that location to avoid losing other profiles.

1. Press **Menu**. Choose 'System settings', 'Network' and then 'Network profile'. Press **Tuning** to see the stored profiles. The profile which is currently in use (if any) is marked with an asterisk.
2. To remove a profile from memory, rotate **Tuning** to highlight the profile to be deleted and then press the control. The radio will offer a 'YES' or 'NO' selection. Choose 'YES'. The selected profile will be deleted. Note that it is not possible to delete a profile which is currently in use.

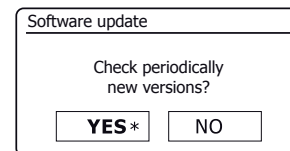
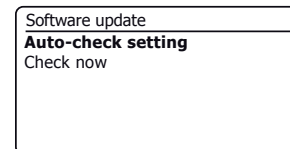
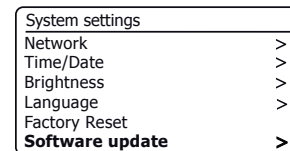

Software version display

The software version display is provided for reference and customer support purposes.

1. Press **Menu**. Choose '*System settings*' and then '*Info*'. The display will show the software version and radio ID. Rotate **Tuning** to display further information.
2. Press **Menu** to exit.

Audio FAQ

Your radio can access some audio help for Internet Radio use.

1. With your radio switched on and in **Internet Radio** mode, press **Menu**. Choose '*Station list*' and then '*Help*' to enter the Help menu.
2. Select '*FAQ*' to display some frequently asked questions.
3. Choose a question that suits your requirements. Adjust the volume as needed.

Friendly name

Your radio uses a Friendly Name so that it is identifiable within remote control software such as the UNDOK app, UPnP server and control software, and the Spotify app. By default, your radio's Friendly Name will be shown as the "Roberts Stream 94i" followed by a 12 digit alphanumeric code which is the network MAC address that is unique to your radio. If you would like to change this name to something more personalised you may either use the UNDOK app or follow the instructions below.

1. Press **Menu** and choose '*System settings*', '*Network*' and then '*View settings*'. The current network settings will be displayed.
2. Rotate **Tuning** until the IP address is showing on the display. This is the local IP address used by your radio on your network. In the example screen to the right the IP address is 192.168.1.27. Make a note of the IP address shown on your radio's display for the next stage.
3. Ensure that your computer is on the same network as the radio. On your computer enter the IP address noted above into the address bar of your web browser. For example, enter 192.168.1.27 followed by Return. This will allow you to view some of the radios settings and will allow you to change the friendly name. Type the new name in the box as shown and then click Apply to save the name. The new Friendly Name will now be visible to network connected devices.

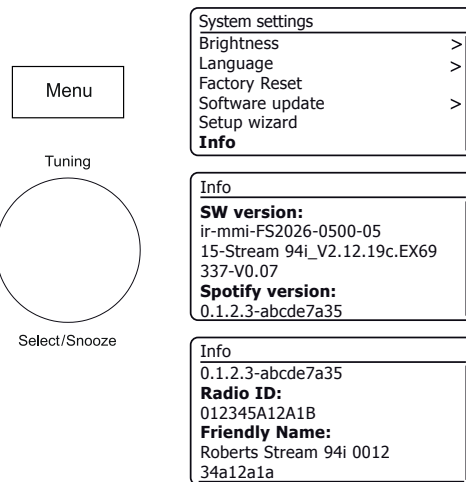

If you experience any trouble with your radio, then you may find it useful to visit the help section on our web site.

If you have difficulty connecting the radio to your computer network, some of these steps may help to resolve the problem:

1. Confirm that a WiFi connected PC can access the Internet (i.e. can browse the web) using the same network.
2. Check that a DHCP server is available (normally a router function). Your radio will by default use DHCP unless you choose to disable it. This may be configured using the menu items *'Main Menu' -> 'System settings' -> 'Network' -> 'Manual settings'*. This will ask first whether you wish to configure a wired or a wireless connection. For either wired or wireless you then need to choose *'DHCP enable'* or *'DHCP disable'*. If you enable DHCP then the radio will negotiate with your router (or DHCP server) and will be provided with an IP address as well as the other settings needed. If you wish to set the network configuration manually, refer to paragraph 6.
3. Check that your network's firewall is not blocking any outgoing ports. As a minimum, the radio needs access to UDP and TCP ports 80 and 123. Port 53 may be required for DNS. Some Internet radio services may require additional ports to be open. Windows Media Player 12 will allocate a port number for UPnP media sharing and will configure Microsoft's Windows built-in firewall appropriately. Other firewall software may require configuration for UPnP or to allow particular IP addresses to have trusted access.
4. Check that your access point does not restrict connections to particular MAC addresses (sometimes called MAC address filtering).

You can view the radio's MAC address using the menu items *'Main Menu' -> 'System settings' -> 'Network' -> 'View settings' -> 'MAC address'*.

The MAC address will typically be of the form

00 : 22 : 61 : xx : xx : xx

5. If you have an encrypted network, check that you have entered the correct encryption key into the radio. Remember that text-format WPA keys are case sensitive. If your radio displays *'Network error'* when attempting to connect to an encrypted network, then please ensure that you enter the correct key for the network. If the problem persists, then you may need to re-check your network configuration.
6. If you need to set up your radio's IP address manually, you will need to know low-level details of your network's configuration. Use the menu items *'Main Menu' -> 'System settings' -> 'Network' -> 'Manual settings' -> 'Wired' or 'Wireless' (as needed) -> 'DHCP disable'*.

The radio will then prompt you in turn for the

Ethernet IP address

Ethernet Subnet mask

Ethernet Gateway address

Ethernet Primary DNS

Ethernet Secondary DNS

If you are setting up a wireless connection manually you will also need to enter the SSID, the encryption type, and the encryption key.

See page 16 for full details on how to set up your radio's network configuration manually.

Troubleshooting - cont.

If your radio can connect to the network, but is unable to play a particular Internet radio station, it may be due to one these causes:

1. The station is not broadcasting at this time of the day.
2. The station has reached its maximum allowed number of simultaneous connections.
3. The Internet connection between your radio and the server (often located in a different country) is slow. This could be due to internet congestion, either locally or at a distance.
4. The station may choose to block internet connections to your geographic region (sometimes known as geo-locking).
5. The station is no longer broadcasting. The database of radio stations that your radio connects to is frequently updated and checked but may not always be completely accurate.
6. The radio station is broadcasting using an audio format which is not playable by your radio (although the Stream 94i does play the most popular formats used by regular broadcasters).

Try using a PC to listen via the broadcaster's web site or via the radio station database web site at <http://www.wifiradio-frontier.com>. If you can play the station with a PC, it may be that the internet feed or local network connection is poor. However, some broadcasters (such as the BBC) provide different data streams for PC users and Internet radio listeners, so this test is not always conclusive.

If you cannot play the station via your PC this may indicate that the problem is not necessarily due to your radio, but it could be your network, your internet connection, the broadcaster, or internet congestion.

Music Player / UPnP problems

The use of the Music Player function with UPnP should be straightforward. However, the cleverness of UPnP means that it is often disabled by default by security applications and in routers.

If you are using Windows Media Player (WMP) as your UPnP server, and if it fails to operate with your radio, please keep this fact in mind: *A fresh installation of Windows and Windows Media Player when using Microsoft's built-in firewall software will normally work.*

If it does not work, possible reasons may include:

- UPnP functions blocked in firewall software
- UPnP functions turned off by security software
- UPnP functions 'hi-jacked' by other software
- UPnP functions blocked in the router
- Multi-cast packets blocked in the router
- IP address of system blocked in firewall software

Some third-party UPnP servers are much less dependent upon other parts of Windows than WMP 12. If the greater flexibility that these offer is attractive, it may also be found in some cases that they are easier to get working.

Audio codecs

Your radio supports a range of audio codecs which provide compatibility with a wide range of Internet Radio stations. These also allow users to stream music from their computers or to play directly from USB flash memory devices.

Note that for any given audio codec, there are many streaming protocols available, and thus even if an Internet Radio station uses a supported format, this does not guarantee that every such station will work with your radio. The radio stations database to which your radio connects is checked for compatibility so that most stations should be playable without problems. Similarly when streaming media from a computer, while a codec may be supported, there can be many subtle variations in formats, tagging schemes and protocols (even within UPnP). In general your radio will play the supported formats with most common UPnP servers.

The following table summarises the maximum supported bit-rates for the various audio formats that are playable on your radio. Higher rates may be playable in some cases but performance of the product may be affected.

Codec	Maximum supported data rate
AAC (LC, HE, HE V2)	320 kbits/sec
ALAC ⁽¹⁾	1.5 Mbits/sec
FLAC ⁽²⁾	1.5 Mbits/sec
LPCM ⁽³⁾	1.536 Mbits/sec
MP3	320 kbits/sec
WAV ⁽³⁾	1.536 Mbits/sec
WMA ⁽⁴⁾	320 kbits/sec

All codecs support 2-channel (stereo) coded files only.

All codecs support sample rates up to 48 k samples/sec (includes 32 k and 44.1 k samples/sec).

Files which have Digital Rights Management (DRM) protection applied will not be playable on your radio.

(1) 16 bit samples are supported in ALAC files.

(2) 16 and 24 bit samples are supported in FLAC files.

(3) The maximum supported bit-rate is for 48 kHz sampling, 2 channels and 16-bits per sample.

(4) WMA Lossless, WMA Voice, WMA 10 Professional, and files which have DRM protection are not supported.

Cautions

Do not allow your radio to be exposed to water, steam or sand.
Do not leave your radio where excessive heat could cause damage.
The name plate is located on the rear of the radio.



- The AC/DC adaptor and radio shall not be exposed to dripping or splashing and no objects filled with liquids, such as vases, shall be placed on the AC/DC adaptor or the radio.
- It is recommended to operate the product such that there is a minimum distance (10cm recommended) to adjacent objects in order to ensure good ventilation.
- The ventilation of the product should not be restricted by covering it with items such as newspapers, tablecloths, curtains etc.
- No naked flame sources such as lighted candles should be placed on the product.
- It is recommended to avoid using or storing the product at extremes of temperature. Avoid leaving the unit in cars, on window sills, in direct sunlight etc.
- The AC/DC adaptor and radio must be used in a moderate climate.
- There are no user serviceable parts inside this product.
- Do not attempt to disassemble any part of the product.

Specifications

Power Requirements

Mains	230 volts AC, 50Hz  only (use only supplied adaptor)
Remote Control Battery	1 x CR2025

Connectivity

Wired Ethernet	10/100M bits/sec via RJ-45 connector
WiFi	802.11 b, g, n or a supported with WEP and WPA / WPA2 encryption
Compatible with 2.4 GHz and 5 GHz WiFi bands.	

Frequency Coverage

FM	87.5 - 108MHz
DAB	174.928 - 239.200MHz
Bluetooth	2.402 - 2.480GHz

Headphone socket	3.5mm diameter, stereo
Aux In socket	3.5mm diameter, stereo
Line out socket	3.5mm diameter, stereo

Aerial System	WiFi Built-in antenna DAB/FM Telescopic aerial
---------------	---

Bluetooth standards	A2DP, AVRCP
Bluetooth codecs supported	SBC and AAC

Operating temperature range +5°C to +40°C

The Company reserves the right to amend the specification without notice.

Use of the software in this radio is subject to software licence terms contained in this user manual - by using the radio, you are agreeing to comply with these licence terms:

Thompson Licensing: MP3 audio decoder

MPEG Layer-3 audio coding technology licensed from Fraunhofer IIS and Thomson

Fraunhofer: MPEG-4 HE AAC Audio decoder

MPEG-4 HE-AAC audio coding technology licensed by Fraunhofer IIS:

<http://www.iis.fraunhofer.de/amm/>



Microsoft: Windows Media Audio decoder (WMA)

This product is protected by certain intellectual property rights of Microsoft. Use or distribution of such technology outside of this product is prohibited without a license from Microsoft.

Microsoft: Real Time Streaming Protocol (RTSP)

This product is protected by certain intellectual property rights of Microsoft. Use or distribution of such technology outside of this product is prohibited without a license from Microsoft.

Spotify: Spotify Connect

The Spotify software is subject to third party licenses found here:

<http://www.spotify.com/connect/third-party-licenses>

Guarantee

This product is guaranteed for twenty four months from the date of purchase by the original owner against failure due to faulty workmanship or component breakdown, subject to the procedure stated below. Should any component or part fail during this guarantee period it will be repaired or replaced free of charge.

The guarantee does not cover:

1. Damage resulting from incorrect use.
 2. Consequential damage.
 3. Product with removed or defaced serial numbers.
- N.B. Damaged or broken telescopic aerials will not be replaced under guarantee.

Procedure:

Any claim under this guarantee should be made through the dealer from whom the product was purchased. It is likely that your Roberts' dealer will be able to attend to any defect quickly and efficiently, but should it be necessary the dealer will return the product to the company's service department for attention. In the event that it is not possible to return the product to the Roberts dealer from whom it was purchased, please contact Roberts Radio using the contact details on the www.robertsradio.com website.

For product repairs falling outside the guarantee period, please refer to the "Customer care" tab on the www.robertsradio.com website.

These statements do not affect the statutory rights of a consumer.

ROBERTS RADIO LIMITED

PO Box 130

Mexborough

South Yorkshire

S64 8YT



Website: <http://www.robertsradio.com>

© 2017 Roberts Radio Limited

