



TACTICAL ASSAULT COMMANDER -MECHANICAL KEYPAD-

for PlayStation®5 consoles, PlayStation®4 consoles, PC

Instruction Manual

EN

Compatible only with keyboard & mouse enabled titles

Compatible Software

<https://stores.horiusa.com/tac5compatibility>





Caution

Parents / Guardians: Please read the following information carefully.

- This product contains small parts. Keep away from children under 3 years old.
- Keep this product away from small children or infants. Seek medical attention immediately if any small parts are swallowed.
- Long cord. Strangulation hazard.
- Keep the product away from dusty or humid areas.
- Do not use this product if it has been damaged or modified.
- Do not get this product wet. This may cause an electric shock or malfunction.
- Do not place this product near heat sources or leave under direct sunlight for an extended period. Overheating may cause malfunction.
- Do not use this product with a USB hub. The product may not function properly.
- Do not connect to a USB battery charger or USB memory stick. Doing so may cause the hardware to malfunction and may also corrupt the data.
- Do not touch the metal parts of the USB plug.
- Do not touch the headset jack or USB port with bare hands.
- Do not apply strong impact or weight on the product.
- Do not pull roughly or bend the cable of the product.
- Do not pull the buttons.
- Do not disassemble, modify, or attempt to repair this product.
- If product needs cleaning, use only a soft dry cloth. Do not use any chemical agents like benzene or thinner.
- The wires are not to be inserted into socket-outlets.
- The packaging must be retained since it contains important information.
- The normal function of the product may be disturbed by strong electro-magnetic interference. If so, simply reset the product to resume normal operation by following the instruction manual (How to Connect). In case the function does not resume, please relocate to an area which does not have electro-magnetic interference to use the product.
- Do not use this product for anything other than its intended purpose. We are not responsible for any accidents or damage in the event of use other than the intended purpose.
- We are not liable for any data loss or damages caused by the mishandling of the product by the user.

Table of Contents

Included	1
How to Connect	2
Compatibility	4
Troubleshooting	4
Layout	5
Keyboard Function Layer	6
[HORI Device Manager] app	8
Assigning Key Functions	8
Switching Profiles	9
Reset to Default (Key Settings)	10
Palm Rest Adjustment	10
Connecting Headsets	10
Specifications	10

Included

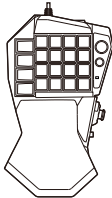

Mechanical Keypad × 1

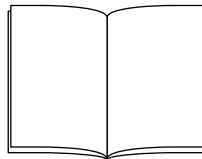

Instruction Manual × 1

Mouse not included

1 Connect your mouse (USB cable or USB dongle) to the USB port on the TAC Keypad.

Wired mouse (USB Type-A)

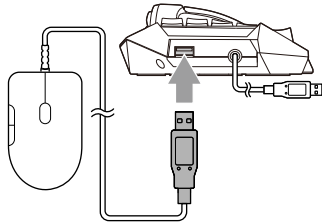

Wireless mouse (USB dongle type)

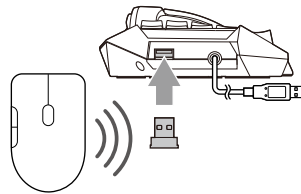

- Bluetooth® wireless mice cannot connect directly to the TAC.
- If using a Bluetooth® wireless mouse, please connect directly to the console.
- Do not attempt to connect USB batteries / power banks, chargers, or USB memory sticks to the TAC and your mouse.

2 Set the System Select Switch to the appropriate setting.

Set the System Select Switch before connecting to the hardware.
(Product will not function properly if the wrong mode is selected.)

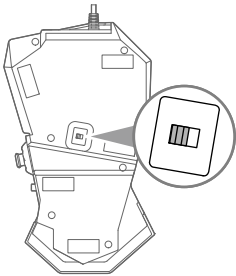

PS5™ console

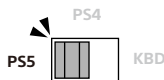

PS4™ console

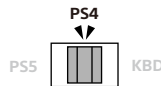

When using with PC



* KBD - Keyboard Mode

3 Connect the product to the console. Then press the (PS) button on the DualSense™ Wireless Controller (or DUALSHOCK®4 Wireless Controller) to turn on the console and log in.

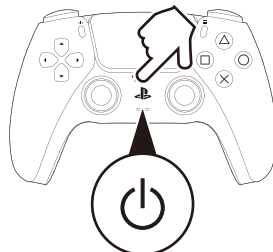
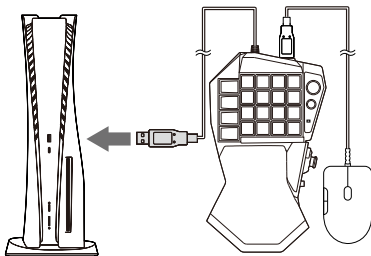

4 Push the (PS) button on the TAC.

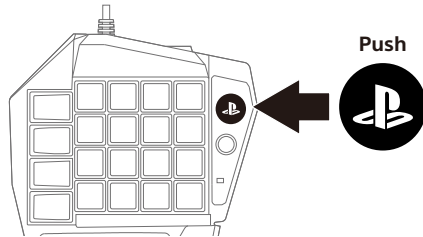

5 While holding the FN Key, use the WASD keys, 3 (O) key, and 4 (X) key to log in and operate the Home Screen.

Use the FN Key to switch the functions of other keys. Refer to "Keyboard Function Layer" (P. 7) for more details.

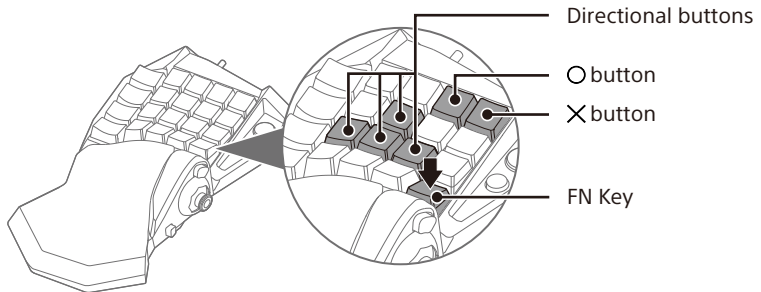

6 After logging in, you may also use the Analog Stick, Enter (Select), and ESC (Return) to operate Home Screen and select software.

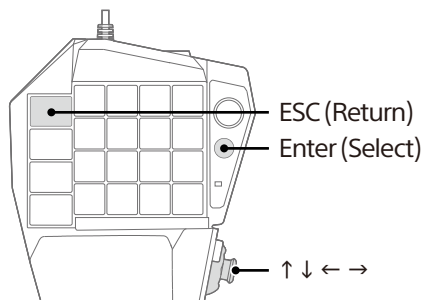

- Make sure the game is compatible with keyboard and mouse mode. (Please see QR Code / website on the first page.)
- If keyboard mode does not function, hold FN key and select control option in game to select keyboard and mouse mode if available.

PlayStation®5 consoles, PlayStation®4 consoles, PC*

* PC compatibility not tested nor endorsed by Sony Interactive Entertainment.

Important

Please read the manual for the console before using this product.
Please check that the console is updated to the latest system software.

PS5™ consoles

Recommended software version	Ver. 22.01-05.10.00 or above
------------------------------	------------------------------

PS4™ consoles

Recommended software version	Ver. 9.60 or above
------------------------------	--------------------

PC

Supported OS	Windows® 11 / 10
System Requirements	USB port (Type-A), internet connection

Compatible only with keyboard & mouse enabled titles. (Please see QR Code / website on the first page.)

Troubleshooting



① PS5™ console / PS4™ console does not power ON after pressing the (PS) button on the keypad

Pressing the  (PS) button on the keypad will not power ON the console.
Please power on the console normally before use.

② (PS) button does not respond

Check that the System Select Switch on the bottom of the keypad is set to the correct mode. (See "How to Connect" on P.2)
Please check that your console is updated to the latest system software.
(PS5™ console : Ver. 22.01-05.10.00 or above / PS4™ console : Ver. 9.60 or above)

③ The product is unresponsive after turning on the PS5™ console or PS4™ console by pressing the (PS) button on the DualSense™ Wireless Controller or DUALSHOCK®4 Wireless Controller

If the PS5™ console or PS4™ console is turned on with  (PS) button on the DualSense™ Wireless Controller or DUALSHOCK®4 Wireless Controller, make sure you sign in using the DualSense™ Wireless Controller or DUALSHOCK®4 Wireless Controller. From the Home Screen, push  (PS) button on the TAC to sign in with the TAC.

④ Can move the controls on the home screen but not during gameplay

Make sure the software has keyboard & mouse compatibility. (Please see QR Code / website on the first page.)
Make sure that you are logged in to the account that was used when the game was started.
If the mouse does not function properly, please unplug the mouse from the TAC and unplug the TAC from the PS5™ console or PS4™ console, then reconnect.

⑤ Cannot use this product while using the DualSense™ Wireless Controller or the DUALSHOCK®4 Wireless Controller

TAC will not respond when the DualSense™ Wireless Controller or the DUALSHOCK®4 Wireless Controller is in use during the gameplay because the console is in the controller mode. When switching to Keyboard & Mouse Mode, push the  (PS) button on the TAC and log in with TAC.

⑥ Mouse does not respond

- This product will not work with mice that are not HID compatible and that are over 200 mA.
Connect the mouse directly to the console. If it still does not respond, please contact the manufacturer of the mouse.
- Unplug the mouse from this product and then remove this product from each hardware unit. If the product does not work even if you reconnect from step 1 of "How to Connect" (P.2), please use a different mouse.

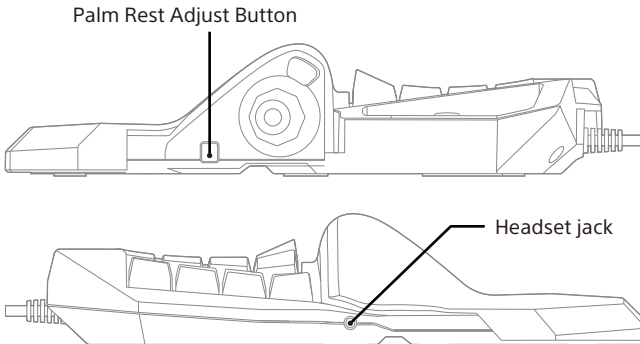
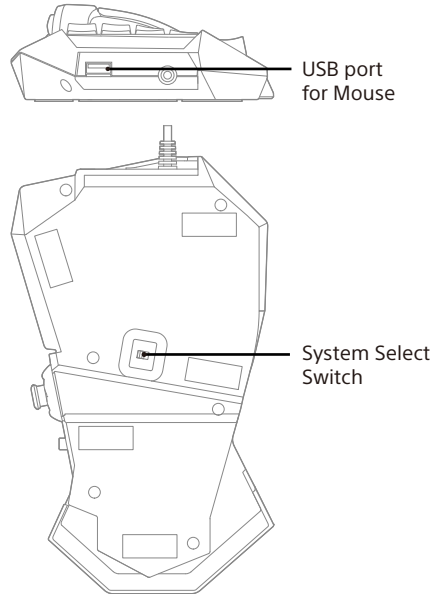
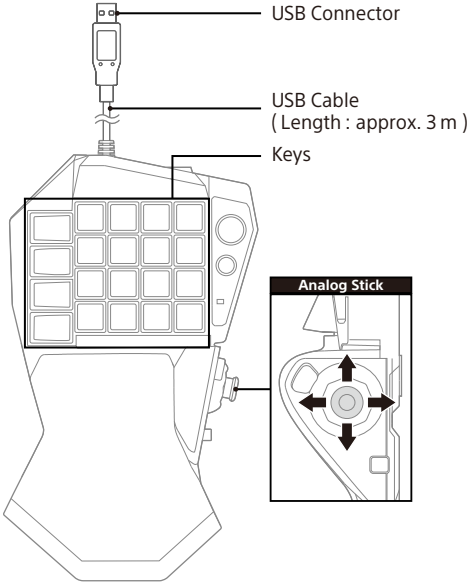

Mouse Layout

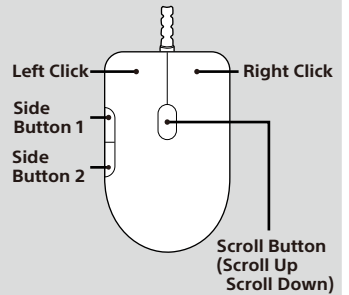

- Mouse not included.
- Additional buttons will not respond for mice with more than 5 buttons.

Keys used mainly during gameplay.

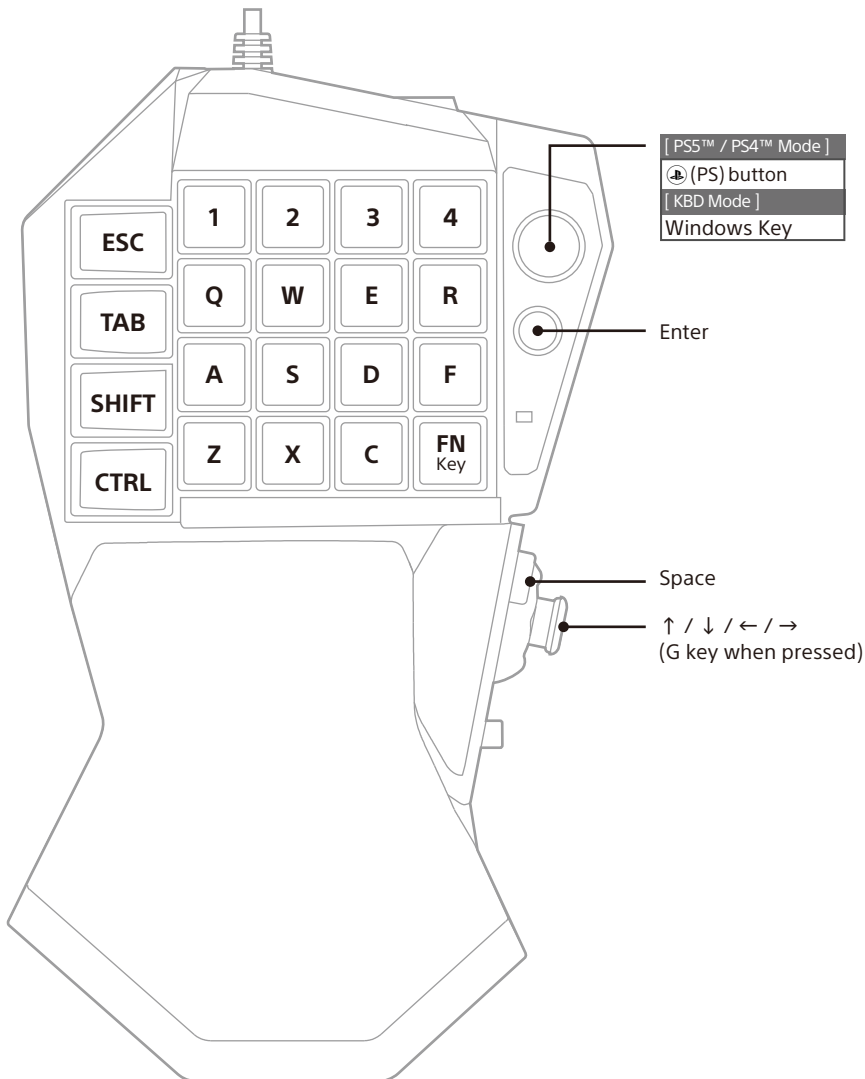

PS5™ console / PS4™ console Home Screen Layer

Hold FN key to activate the PS5™ console / PS4™ console Home Screen Layer.
Use this to operate the Home Screen on PS5™ console / PS4™ console.

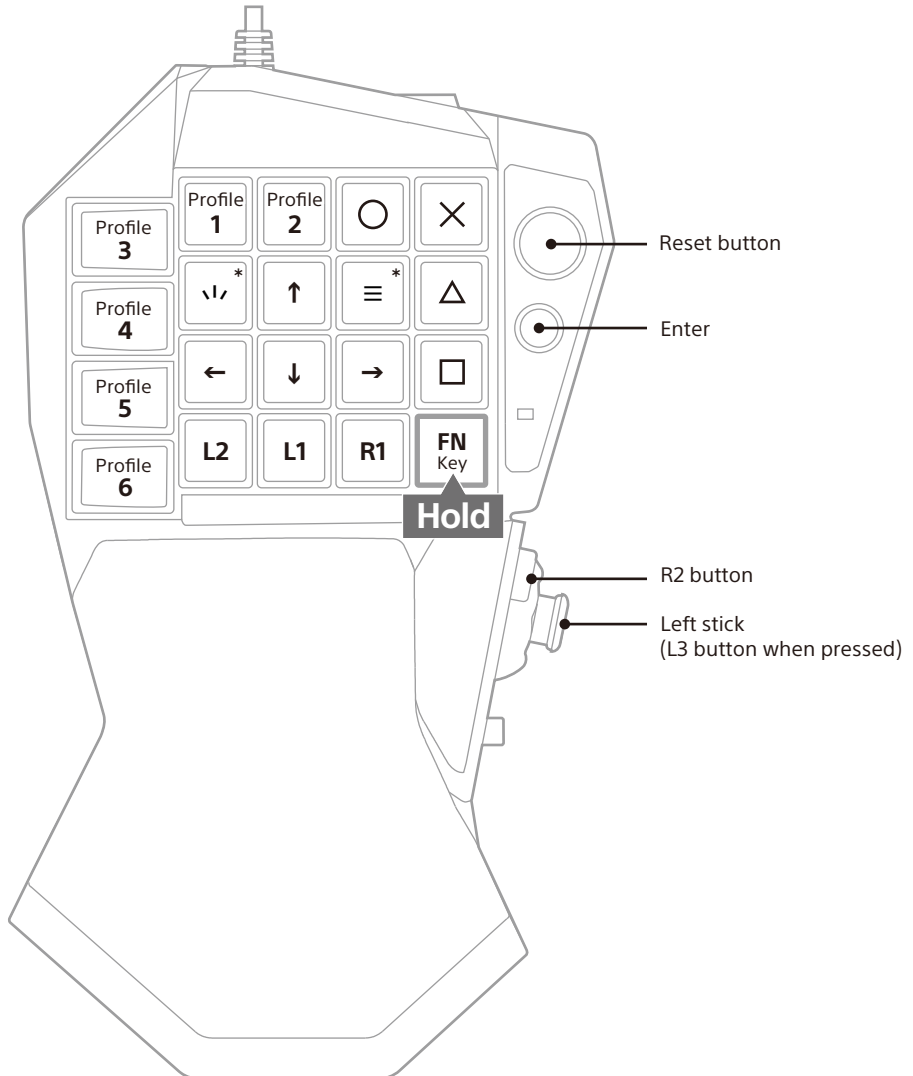

* [PS5™] ↘ (Create) button / [PS4™] SHARE button
[PS5™] ≡ (Options) button / [PS4™] OPTIONS button



HORI Device Manager

Set the following features with the [HORI Device Manager] smartphone app

- [Assign] Function
Customize the keys to match your gaming style. (Please see "Assigning Key Functions" below)
- DP / LS / RS
D-Pad (DP), Left stick (LS), Right stick (RS) input can be assigned to the Analog Stick.
(This function is only for PS5™ console / PS4™ console mode)
- Backlight
Turn LED backlight On / Off.
- [Assign Profile] Reset
Reset all key assignments of the selected profile.

How to Download

iPhone (iOS : 15.4 or above)

1. Search "HORI" or "HORI CO., LTD." in the App Store.
2. Install "  HORI Device Manager".

Smartphone (Android : 10 or above)

1. Search "HORI" or "HORI CO., LTD." in Google Play.
2. Install "  HORI Device Manager".

- Please check that your device is up to date.
- Make sure that the app is released by "HORI CO., LTD."
- Bluetooth® connection required. Please allow the app to have access to "location information, photos, media, and files". Press "Search" and select the product to complete pairing.

Assigning Key Functions

Customize keys in the [HORI Device Manager] app

 (PS) button, FN key, and Profile 1-6 keys cannot be assigned to other buttons / keys.



The following key functions can be set:

Alphabet	A-Z
Numbers	0-9
Function	F1-F2
Special Key	Esc, Tab, Caps Lock, Shift, Ctrl, Alt, Space, Enter, Back Space, Delete
Arrow keys (Up / Down / Left / Right)	↑ ↓ ← →
Other	Print Screen, Scroll Lock, Pause / Break, Insert, Home, Delete, End, Page Up, Page Down NC Key (Button Function Disabled)*, FN Key
Keypad	Num Lock, Num /, Num *, Num -, Num +, Num Enter, Num ., Num 0 - Num 9
Mouse Functions	Right Mouse Button, Left Mouse Button, Scroll Button, Scroll Up, Scroll Down, Side Button 1, Side Button 2

These functions can only be set to the PS5™ console / PS4™ console Home Screen Layer.

△ button, ○ button, × button, □ button, L1 button, R1 button, L2 button, R2 button, L3 button, R3 button, [PS5™] ↵ (Create) button, [PS4™] SHARE button, [PS5™] ≡ (Options) button, [PS4™] OPTIONS button, Mute button*, Push to Talk button*	
Directional buttons	↑ ↓ ← → ↶ ↷ ↸ ↹
Left Stick	↑ ↓ ← → ↶ ↷ ↸ ↹
Right Stick	↑ ↓ ← → ↶ ↷ ↸ ↹

* The following features can also be set :

-  NC Key (Button Function Disabled) : When this function is assigned, the button will be disabled.
-  Mute button : On / off for mic mute will be enabled.
-  Push to Talk button : Chat function is enabled while pressing the Push to Talk button.
Mic will be muted when the button is released.

Switching Profiles

Use HORI Device Manager app to set profiles.

Save key settings for up to 6 profiles (per console).

Instantly switch between profiles by pressing the FN key and Profile 1-6 key .

The LED will change according to the profile that is selected.

Hold FN key and press Profile 1-6 to change between the profiles.

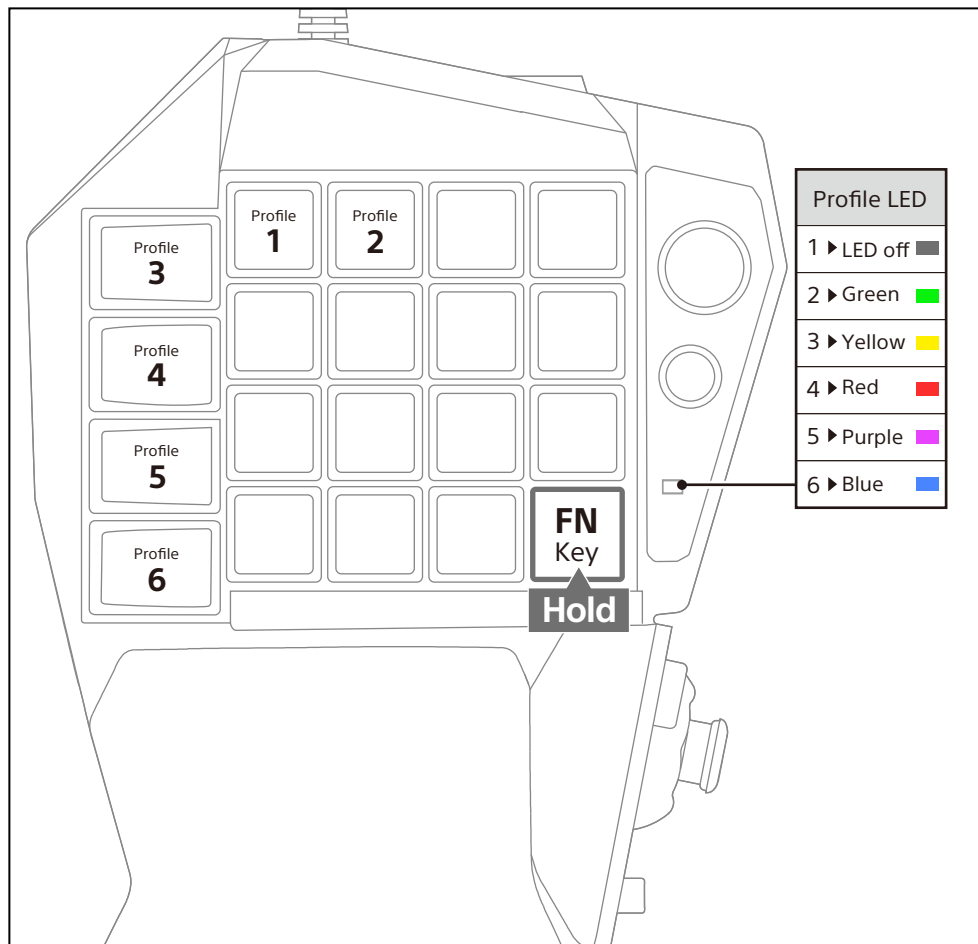

Reset to Default (Key Settings)

Reset key setting of current profile to default.

To Reset

1. Press and hold the FN key and the  (PS) button (Reset button) simultaneously for 5 seconds.
2. The Profile LED will flash and current key settings will reset to default.

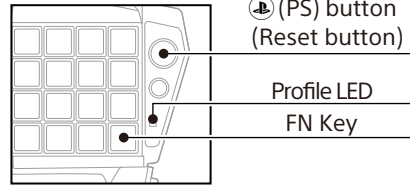

Palm Rest Adjustment

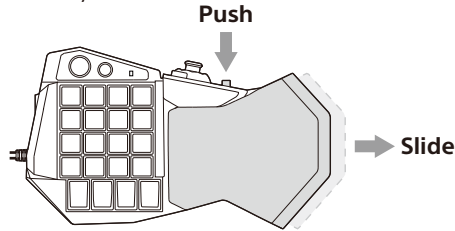

Adjust the palm rest to match the size of your hand.

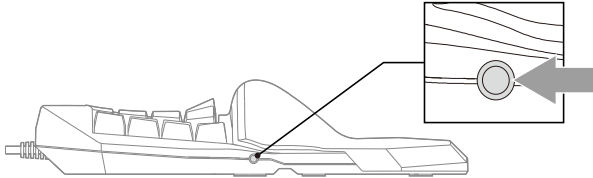

Connecting Headsets

Headphones and headsets can be used when connected to the headset jack. Be careful of the volume when using headphones or headsets.



-  **Avoid exposure to loud noises for an extended period.**
-  **Headset jack is not compatible with PC. Please connect headset directly to the PC.**

* Set mute / push to talk functions with HORI Device Manager app.

Specifications

External Dimensions	: W 135 × D 225 × H 56 mm
Weight	: 385 g (Including cable)
Cable Length	: 3.0 m
Connection Method	: USB Type-A
Headset Jack	: Φ 3.5 mm 4 ring plug

THE FCC WANTS YOU TO KNOW

This device complies with part 15 of the FCC Rules. Operation is subject to the following two conditions: (1) This device may not cause harmful interference, and (2) this device must accept any interference received, including interference that may cause undesired operation.

NOTE: This equipment has been tested and found to comply with the limits for a Class B digital device, pursuant to part 15 of the FCC Rules. These limits are designed to provide reasonable protection against harmful interference in a residential installation. This equipment generates, uses and can radiate radio frequency energy and, if not installed and used in accordance with the instructions, may cause harmful interference to radio communications. However, there is no guarantee that interference will not occur in a particular installation.

If this equipment does cause harmful interference to radio or television reception, which can be determined by turning the equipment off and on, the user is encouraged to try to correct the interference by one or more of the following measures:

- Reorient or relocate the receiving antenna.
- Increase the separation between the equipment and receiver.
- Connect the equipment into an outlet on a circuit different from that to which the receiver is connected.
- Consult the dealer or an experienced radio/TV technician for help.

Simplified Declaration of Conformity

Hereby, HORI declares that this product is in compliance with Directive 2014/53/EU.

The full text of the EU declaration of conformity is available at the following internet address:

<https://hori.co.uk/consumer-information/>

For UK: Hereby, HORI declares that this product is in compliance with the relevant statutory requirements.

The full text of the declaration of conformity is available at the following internet address:

<https://hori.co.uk/consumer-information/>

PRODUCT DISPOSAL INFORMATION

Where you see this symbol on any of our electrical products or packaging, it indicates that the relevant electrical product or battery should not be disposed of as general household waste in Europe. To ensure the correct waste treatment of the product and battery, please dispose of them in accordance with any applicable local laws or requirements for disposal of electrical equipment or batteries. In so doing, you will help to conserve natural resources and improve standards of environmental protection in treatment and disposal of electrical waste. Applicable to EU countries and Turkey only.



EU and Turkey only

US

Warranty

HORI warrants to the original purchaser that the product purchased new in its original packaging shall be free of any defects in material and workmanship for a period of 1 year from the original date of purchase.

If the warranty claim cannot be processed through the original retailer, please address directly to HORI at info@horiusa.com.

Please visit <http://stores.horiusa.com/policies/> for warranty details.

EU

Warranty

For all warranty claims made within the first 1 year after purchase, please check with the retailer where the original purchase was made for details.

If the warranty claim cannot be processed through the original retailer or for any other inquiries pertaining to our products, please address directly to HORI at info@horuk.com.

Actual product may differ from image.

The manufacturer reserves the right to change the specifications of the product without any notification.

HORI & HORI logo are registered trademarks of HORI.

"PS", "PlayStation", "PS5", "PS4", "DualSense", and "DUALSHOCK" are registered trademarks or trademarks of Sony Interactive Entertainment Inc.

Manufactured and distributed under license from Sony Interactive Entertainment.

All other trademarks are the property of their respective owners.